

SERVICE MANUAL

© 2001-2/B51-5702-00 (K/K) 2148

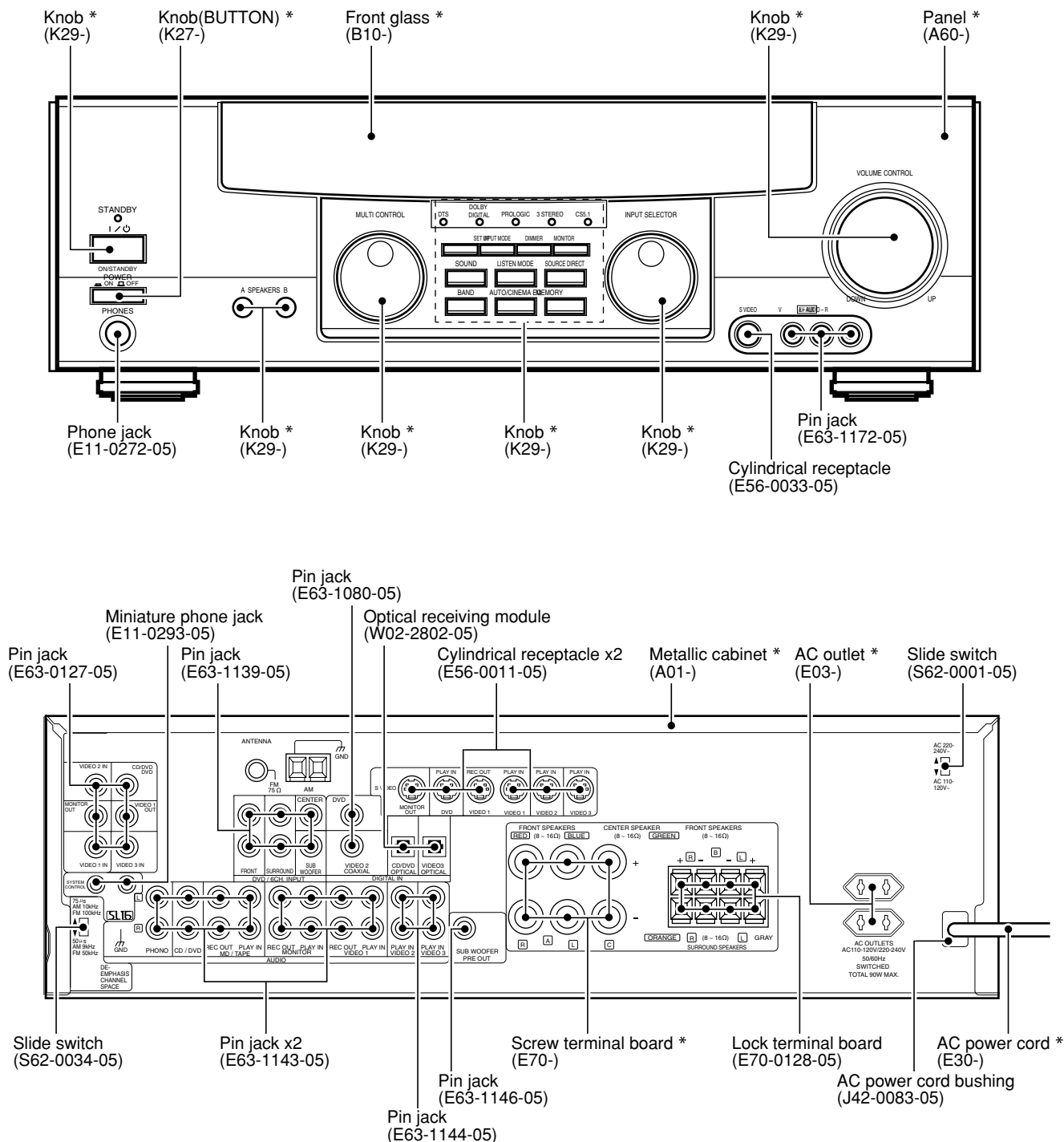

Illustration is KRF-V7050D(M).

* Refer to parts list on page 35.





KRF-V5050D/V5550D/V6050D/V7050D/X9050D

CONTENTS / ACCESSORIES

Contents

CONTENTS / ACCESSORIES	2	EXPLODED VIEW	34
WIRING DIAGRAM	3	PARTS LIST	35
PC BOARD	9	SPECIFICATIONS	48
SCHEMATIC DIAGRAM	15		

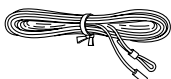
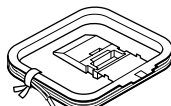
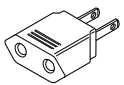
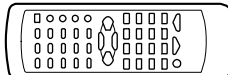
Accessories

<p>FM indoor antenna (1) (T90-0877-05)</p> 	<p>AM loop antenna (1) (T90-0852-05)</p> 	<p>*AC plug adaptor (1) (E03-0115-05)</p> 	<p>* Use to adapt the plug on the power cord to the shape of the wall outlet. (Accessory only for regions where use is necessary.)</p>
<p>Remote control unit (1)</p> 	<p>Batteries (R6/AA)</p> 		

Mdel name vs remote controller

MODEL	Destinations	Remote controller		
		Parts number	Model name	Battery cover
KRF-V5050D	Y	A70-1468-15	RC-R0511	A09-1178-08
KRF-V5050D-S	MIX	A70-1468-15	RC-R0511	A09-1178-08
KRF-V5050D	ET	A70-1469-05	RC-R0512	A09-1178-08
KRF-V5050DE	E3	A70-1469-05	RC-R0512	A09-1178-08
KRF-V5050D-S	E2T2	A70-1469-05	RC-R0512	A09-1178-08
KRF-V5550D-S	MY	A70-1507-05	RC-R0617	A09-1178-08
KRF-V6050D	Y	A70-1466-15	RC-R0615	A09-1178-08
KRF-V6050D-S	MIX	A70-1466-15	RC-R0615	A09-1178-08
KRF-V6050D	E	A70-1467-05	RC-R0616	A09-1178-08
KRF-V7050D	Y	A70-1464-15	RC-R0613	A09-1178-08
KRF-V7050D-S	MIX	A70-1464-15	RC-R0613	A09-1178-08
KRF-V7050D	ET	A70-1465-05	RC-R0614	A09-1178-08
KRF-X9050D	Y	A70-1480-05	RC-R0714	A09-1215-08
KRF-X9050D-S	MIX	A70-1480-05	RC-R0714	A09-1215-08
KRF-X9050D	ET	A70-1481-05	RC-R0715	A09-1215-08

Cautions

Resetting the Microcomputer

The microcomputer may malfunction (unit cannot be operated, or shows an erroneous display) if the power cord is unplugged while the power is ON, or due to some other external factors. If this happens, execute the following procedure to reset the microcomputer and return the unit to its normal operating condition.

With the power cord plugged in, turn the POWER key OFF. Then, while holding down the ON/STANDBY key, press POWER key.

- Please note that resetting the microcomputer will clear the contents of the memory and returns the unit to the state it was in when it left

KRF-V5050D/V5550D/V6050D/V7050D/X9050D

CIRCUIT DESCRIPTION

1. Initial and Backup Function

1-1 Initial State

Below are set value if the microcomputer is initialized when reset:

(1) AMP function initialization

• POWER	POWER OFF (STANDBY)
• Input Selector	TUNER
• Preset device	None
• Visual output	VIDEO1
• Speaker A relay	ON
• Speaker B relay	OFF
• Volume	-66dB
• BASS	0dB
• TREBLE	0dB
• INPUT LEVEL	0dB
• SOURCE DIRECT	0dB
• MONITOR	0dB
• VIDEO2/MONITOR	VIDEO2
• MD/TAPE	TAPE
• RF BAND	BAND 1

(2) SURROUND function initialization

• LISTEN MODE	STEREO
• INPUT MODE	
CD/DVD	DIGITAL AUTO
VIDEO2	ANALOG
VIDEO3	ANALOG
DVD/6ch	DIGITAL AUTO
• SUBWOOFER	ON

• FRONT speaker size	LARGE
• CENTER speaker size	NORMAL
• SURROUND speaker size	NORMAL
• DISTANCE	Fch 3.0m / 10ft
Cch	3.0m / 10ft
Sch	1.5m / 5ft
• LEFT level	0dB
• RIGHT level	0dB
• CENTER level	0dB
• REAR (SL,SR) level	0dB
• SUBWOOFER level	0dB
• MIDNIGHT	OFF
• CINEMA EQ	OFF

(3) TUNER function initialization

• BAND	FM
• PRESET CHANNEL	" _ _ "
• Frequency receive	Each destination minimum value
K1/K2	FM : 87.50 MHz
E1	AM : 530 kHz
E1	FM : 87.50 MHz
E1	AM : 531 kHz
• AUTO MANUAL	AUTO

1-2 Backup Function

When the AC power supply is turned off, the receiver micro-computer enters the backup mode. As a result, it will return to the last state before the AC OFF when the AC power supply is turned ON again

2. Destination List of Tuner

0 : Pull down, 1: Pull up

SET TYPE	TYPE	BAND	RECEIVING FREQUENCY RANGE	CHANNEL SPACE	IF	PLL	Tuner Destination Port			
							PORT3(68PIN) (CP205)	PORT2(67PIN) (W109)	PORT1(66PIN) (W105)	PORT0(65PIN) (W106)
K, P, R	K1 1700	FM	87.5MHz-108.0MHz	100kHz	+10.7MHz	25kHz	0	0	0	0
		AM	530kHz-1700kHz	10kHz	+450kHz	10kHz				
Y, M, I, C, V	K2 1610	FM	87.5MHz-108.0MHz	100kHz	+10.7MHz	25kHz	0	0	0	1
		AM	530kHz-1610kHz	10kHz	+450kHz	10kHz				
Y	K3 1610 RBDS	FM	87.5MHz-108.0MHz	100kHz	+10.7MHz	25kHz	0	0	1	0
		AM	530kHz-1610kHz	10kHz	+450kHz	10kHz				
K, P	K4 1700 RBDS	FM	87.5MHz-108.0MHz	100kHz	+10.7MHz	25kHz	1	0	1	0
		AM	530kHz-1700kHz	10kHz	+450kHz	10kHz				
Y, M, I, C, V, E, X, H	E1	FM	87.5MHz-108.0MHz	50kHz	+10.7MHz	25kHz	0	0	1	1
		AM	531kHz-1602kHz	9kHz	+450kHz	9kHz				
T	E2 LW	FM	87.5MHz-108.0MHz	50kHz	+10.7MHz	25kHz	0	1	0	0
		MW	531kHz-1602kHz	9kHz	+450kHz	9kHz				
		LW	153kHz-279kHz	9kHz	+450kHz	9kHz				
E, T	E3 RDS	FM	87.5MHz-108.0MHz	50kHz	+10.7MHz	25kHz	0	1	0	1
		AM	531kHz-1602kHz	9kHz	+450kHz	9kHz				
T	E4 LW RDS	FM	87.5MHz-108.0MHz	50kHz	+10.7MHz	25kHz	0	1	1	0
		MW	531kHz-1602kHz	9kHz	+450kHz	9kHz				
		LW	153kHz-279kHz	9kHz	+450kHz	9kHz				
Q	Q1 RDS	FM L	65.0MHz-74.0MHz	10kHz	+10.7MHz	5kHz	1	0	1	1
		FM H	87.5MHz-108.0MHz	50kHz	+10.7MHz	5kHz				
		AM	531kHz-1602kHz	9kHz	+450kHz	9kHz				
Q	Q2 RDS	FM L	65.0MHz-74.0MHz	10kHz	+10.7MHz	5kHz	1	1	0	0
		FM H	87.5MHz-108.0MHz	50kHz	+10.7MHz	5kHz				
		MW	531kHz-1602kHz	9kHz	+450kHz	9kHz				
		LW	153kHz-279kHz	9kHz	+450kHz	9kHz				
Y, M, I, C, V	M	K2/E1 are decided by Tuner Destination Port 1 input. (0=K2 type 1=E1 type)				0	0	X	1	
Y	Y RBDS	K3/E1 are decided by Tuner Destination Port 0 input. (0=K3 type 1=E1 type)				0	0	1	X	

KRF-V5050D/V5550D/V6050D/V7050D/X9050D

CIRCUIT DESCRIPTION

3. Microprocessor: MN101C49GLE or MN101C49GLD(X14,IC200) 3-1 Microprocessor Periphery block diagram

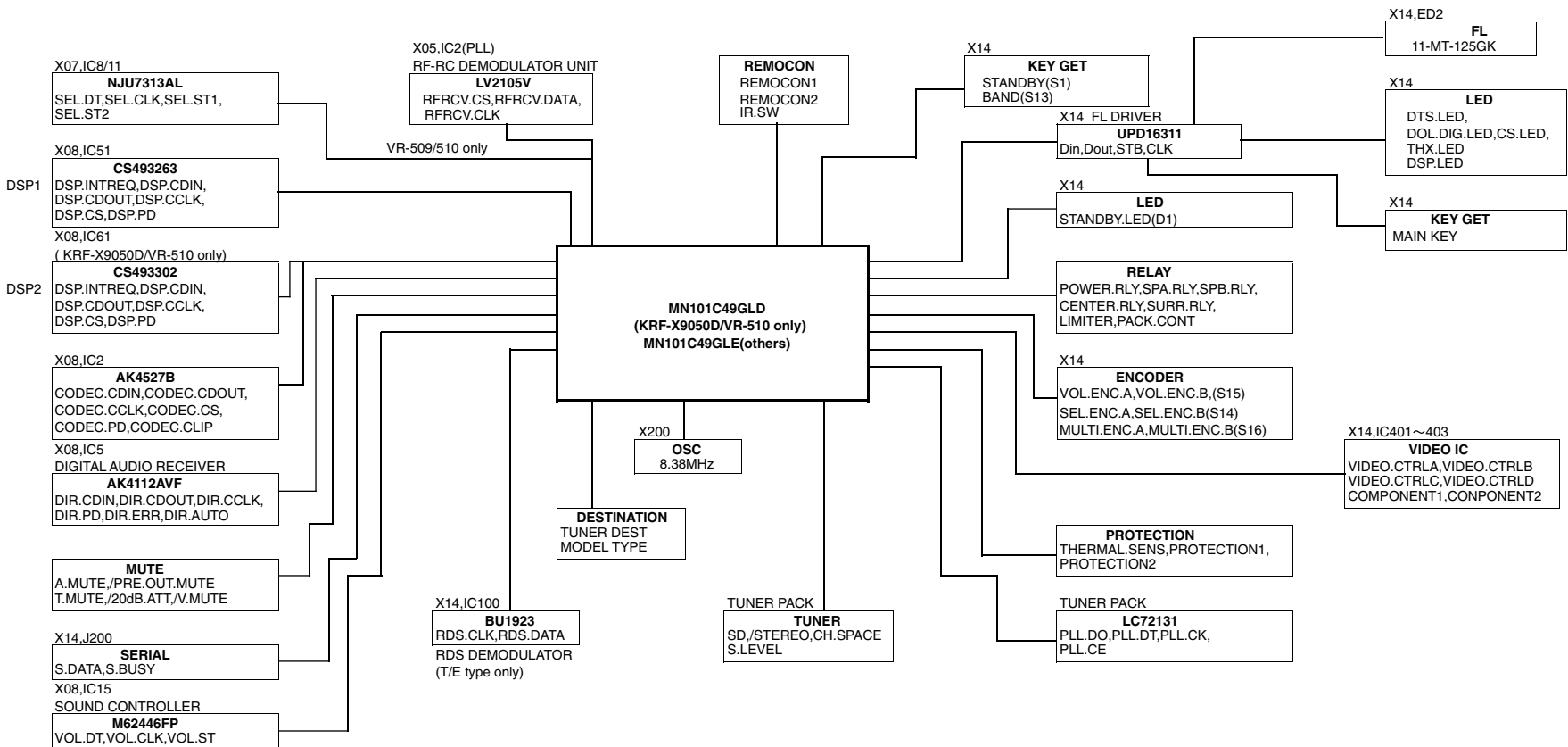

KRF-V5050D/V5550D/V6050D/V7050D/X9050D

CIRCUIT DESCRIPTION

3-2 Pin Description of Microprocessor

Pin No.	Pin Name	I/O	Description
1	VREF	-	Connected to ground.
2	TH SENS	I	Protection signal detection port for thermal sensor.
3	PROT1	I	Protection signal detection port for over current.
4	PROT2	I	Protection signal detection port for over voltage.
5	S LEVEL	-	Detection port of RDS signal level.
6	KEY GET	I	A/D key input for band and standby.
7	CE2	I	Detection port of chip enable 2 for microprocessor.
8	CE1	I	Detection port of chip enable 1 for microprocessor.
9	DIG DET	I	Detection port of digital signal for DTS.
10	VREF	-	A/D reference voltage.
11	VDD	-	Power supply(+5v) for microprocessor.
12	OSC2	O	Main clock output(8.38MHz).
13	OSC1	I	Main clock input(8.38MHz).
14	VSS	-	Connected to ground.
15	XI	-	Connected to ground.
16	XO	-	Unused.
17	MMCD	-	Connected to ground.
18	DIR/CODEC DIN	O	Data output to DIR/CODEC.
19	DIR/CODEC DOUT	I	Data input port from DIR/CODEC.
20	DIR/CODEC CLK	O	Clock output to DIR/CODEC.
21	DSP DIN	O	Data output port to DSP.
22	DSP DOUT	I	Data input port from DSP.
23	DSP CLK	O	Clock output port to DSP.
24	DSP CE1	O	Chip enable 1 output to DSP.
25	DSP CE2	O	Chip enable 2 output to DSP.
26	REM I	I	Remote control signal input 1(Front panel).
27	REM O	I	Remote control signal input 1(Rear panel).
28	DIR ERR	I	Detection port for DIR ERROR signal.
29	RDS CLK	I	Clock input of RDS demodulator IC.
30	DPS IRQ1	I	Detection port 1for DSP INTREQ.
31	DPS IRQ2	I	Detection port 2 for DSP INTREQ.
32	NC	-	Unused.
33	RESET	I	Reset signal input for microprocessor.
34	DSP PD1	O	PD output port 1for DSP.
35	DSP PD2	O	PD output port 2 for DSP.
36	DIR PD	O	Power down mode port for DIR.
37	CODEC PD	O	Power down mode port for CDDEC.
38	CODEC CLIP	I	Overflow detection port for CODEC analog signal.
39	CODEC CE	O	Chip select for CODEC.
40	RDS DIN	I	Data input of RDS demodulator IC.
41	NC	-	Unused.
42	FL DIN	O	Data output to FL driver.
43	FL DOUT	I	Data input from FL driver.
44	FL CLK	O	Clock output to FL driver.
45	FL CE	O	CE output to FL driver.

KRF-V5050D/V5550D/V6050D/V7050D/X9050D

CIRCUIT DESCRIPTION

Pin No.	Pin Name	I/O	Description
46	TUNER DIN	O	Data output to PLL IC.
47	TUNER CLK	O	Clock output to PLL IC.
48	TUNER CE	O	Chip enable output to PLL IC.
49	TUNER DOUT	I	Data input from PLL IC.
50	TUNER MUTE	O	Mute signal output to PLL IC.
51	TUNER STEREO	I	Stereo signal input from PLL IC.
52	TUNER SD	I	SD signal input from PLL IC.
53	RFRCV CE	O	Chip select output to RF remote control receiving IC.
54	RFRCV DIN	O	Data output to RF remote control receiving IC.
55	RFRCV CLK	O	Clock output to RF remote control receiving IC.
56	S BUSY	I/O	Serial busy signal input/output.
57	S DATA	I/O	Serial data signal input/output.
58	LIMITER	O	Power control for A class.
59	IR SW	O	Switching port of remote control signal.
60	DIR AUTO	I	Non PCM detect port.
61~63	MODEL T0~T3	I	Discrimination port for model type.
64	CH SPACE	I	Discrimination port for channel space.
65~68	TUNER DO~D3	I	Discrimination port(D0~D3) for tuner destination.
69	MULTI CW	I	Encoder (Multi control) upward detection.
70	MULTI CCW	I	Encoder (Multi control) downward detection.
71	SEL CW	I	Encoder (Selector)clockwise detection.
72	SEL CCW	I	Encoder (Selector) counterclockwise detection.
73	VOL. CW	I	Encoder (Vol.)clockwise detection.
74	VOL.CCW	I	Encoder (Vol.) counterclockwise detection.
75	SP. A RLY	O	Relay control for A speaker.
76	CNT/SUB W RELAY	O	Relay control for center and sub speakers.
77	SP. B RLY	O	Relay control for B speaker.
78	SUB W	-	Unused.
79	SURR.RLY	O	Relay control for surround speaker.
80	PWR RLY	O	Control port of power relay.
81	PACK CONT.	O	Power pack control.
82	STANDBY RLY	O	Standby relay control.
83	SURR.MUTE	I	Mute control for surround.
84	20dB ATT.	O	20dB attenuater control.
85	A. MUTE	O	Audio mute control.
86	COMP 1	O	Video component switch control.
87	SEL DIN	O	Data output to selector IC(X08,IC12/14).
88~91	V. CTL A~D	O	Video switch control.
92	SEL. DIN	O	Data output to selector IC(X07,IC8/11).
93	SEL. CLK	O	Clock output to selector IC(X07,IC8/11).
94	SEL. ST1	O	Strobe 1 output to selector IC(X07,IC8).
95	DAVSS	-	Connected to ground.
96	SEL. ST 2	O	Strobe 2 output to selector IC(X07,IC11).
97	VOL. CE	O	Chip enable output to vol. IC (X08,IC15).
98	VOL. CLK	O	Clock output to vol. IC (X08,IC15).
99	V. MUTE	O	Mute control to video selector IC (X14,IC401/402).
100	DAVDD	-	+5V power supply.

CIRCUIT DESCRIPTION

4. AK4112AVF u-com interface port

Pin Name	Pin No.	I/O	Function
PD	7	I	Power Down Mode Pin When "L", the AK4112AVF is power down and reset.
AUTO	5	O	Non PCM Detect Pin "L":No detect, "H":Detect
FS96	17	O	96kHz Sampling Detect Pin "H":fs=88.2kHz or more, "L":fs=54kHz or less.
ERF	18	O	Unlock & Parity Error Output Pin "L":No Error, "H":Error
CSN	25	I	Chip Select pin in Serial Mode
CCLK	26	I	Control Data Clock Pin in Serial Mode
CDTI	27	I	Control Data Input Pin in Serial Mode
CDTO	28	O	Control Data Output Pin in Serial

5. AK4527B u-com interface port

Pin Name	Pin No.	I/O	Function
PDN	17	I	Power Down & Reset Pin
OVF	33	O	Analog Overflow Detect Pin
CSN	41	I	Chip Select Pin
CCLK	42	I	Control Data Clock Pin
CDTI	43	I	Control Data Input Pin

6. Test Mode

6-1 Entering the Test Mode

- While pressing the "BAND" key, plug the power cord into AC wall outlet.

6-2 Cancelling the Test Mode

- Initialized and cancel the test mode if pulling out the power code.

6-3 Contents of the Test Mode

6-3-1 Pch CALL UP/DOWN

Key	Function
DIMMER	Pch CALL UP →01→02→03·····→39→40→
INPUT MODE	Pch CALL DOWN ←01←02←03·····←39←40←

6-3-2 10 Steps Switching of P ch Call

Key	Function
SET UP	Preset Operation

6-3-3 TUNER mute on/off

Key	Function
LISTEN MODE	TUNER mute on/off

6-3-4 Key Operation

- The following operation is available during the all FL lighting up mode only.(only VR-507/509/510)

Operation Keys	Display	Function
SOUND	Normal Indication	RF receiving frequency is made 422MHz for VR-509/510 and 418MHz for VR-507.
LISTEN MODE	FRONT IR	FRONT IR is enabled and remote control is disabled.
SOURCE DIRECT	RF BAND 2	RF receiving frequency is made 428MHz for VR-509/510.

PC BOARD (Component side view)

X00-3000-23 (J70-1417-01)

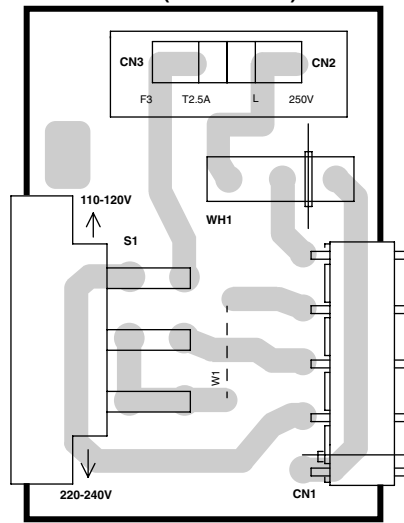

X08-3060-10 (J70-1459-32)

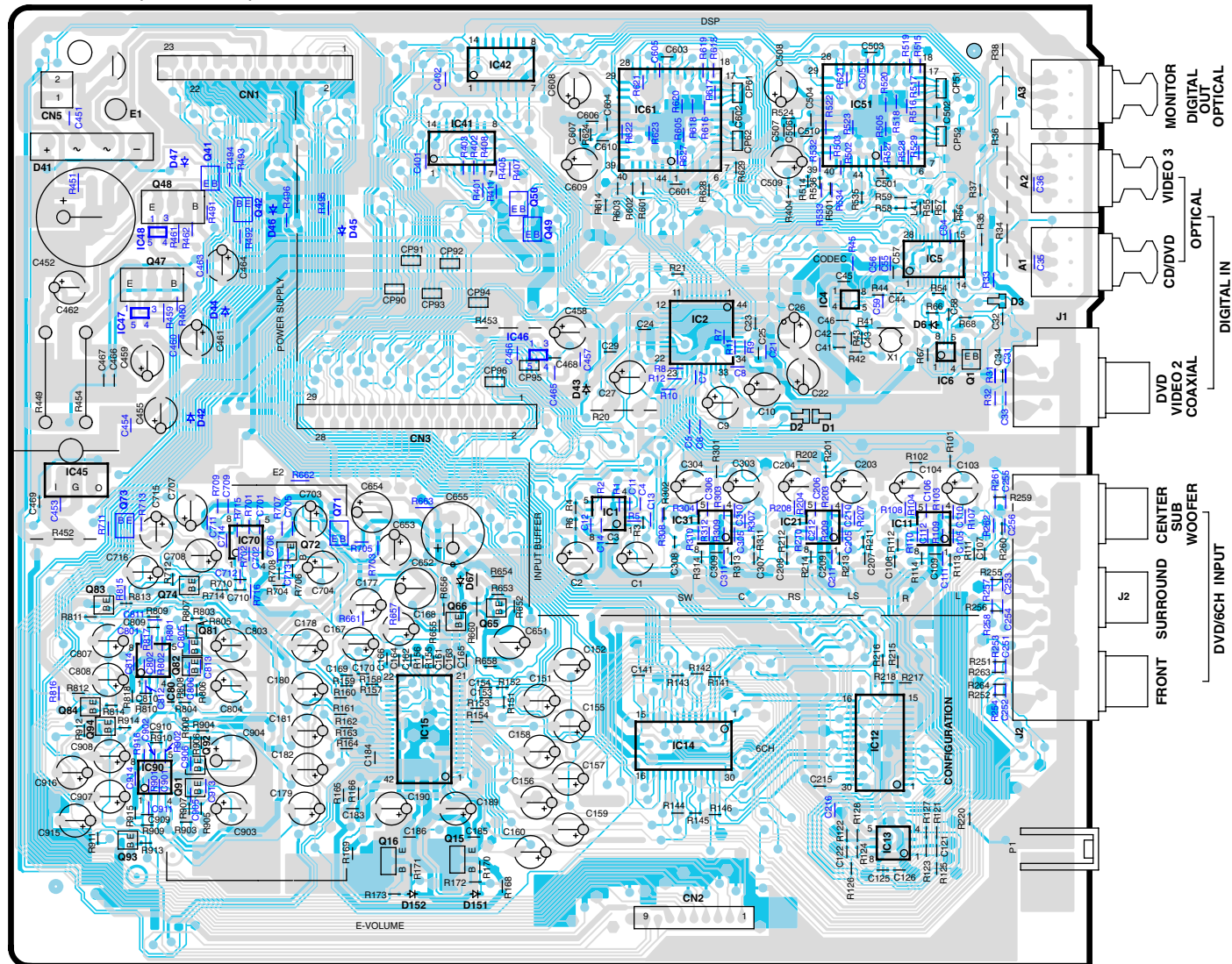

X35-2252-71 (J70-1468-02)

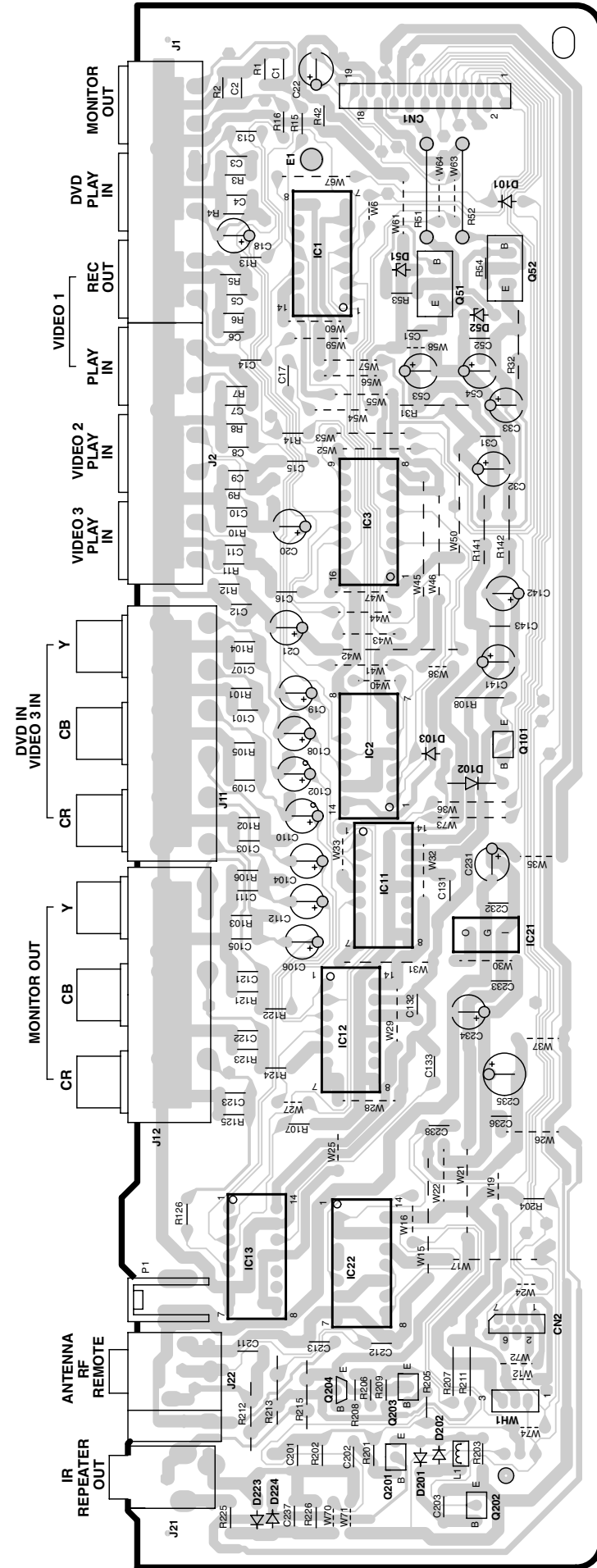

Refer to the schematic diagram for the value of resistors and capacitors.

PC BOARD (Component side view)

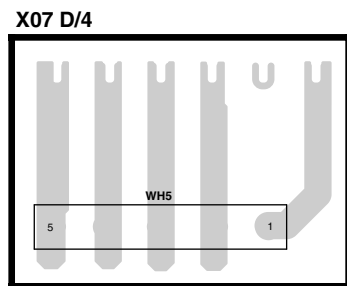
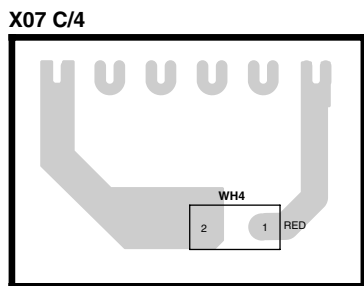
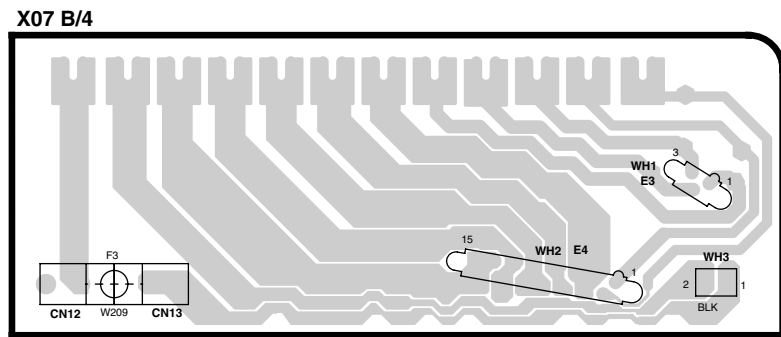
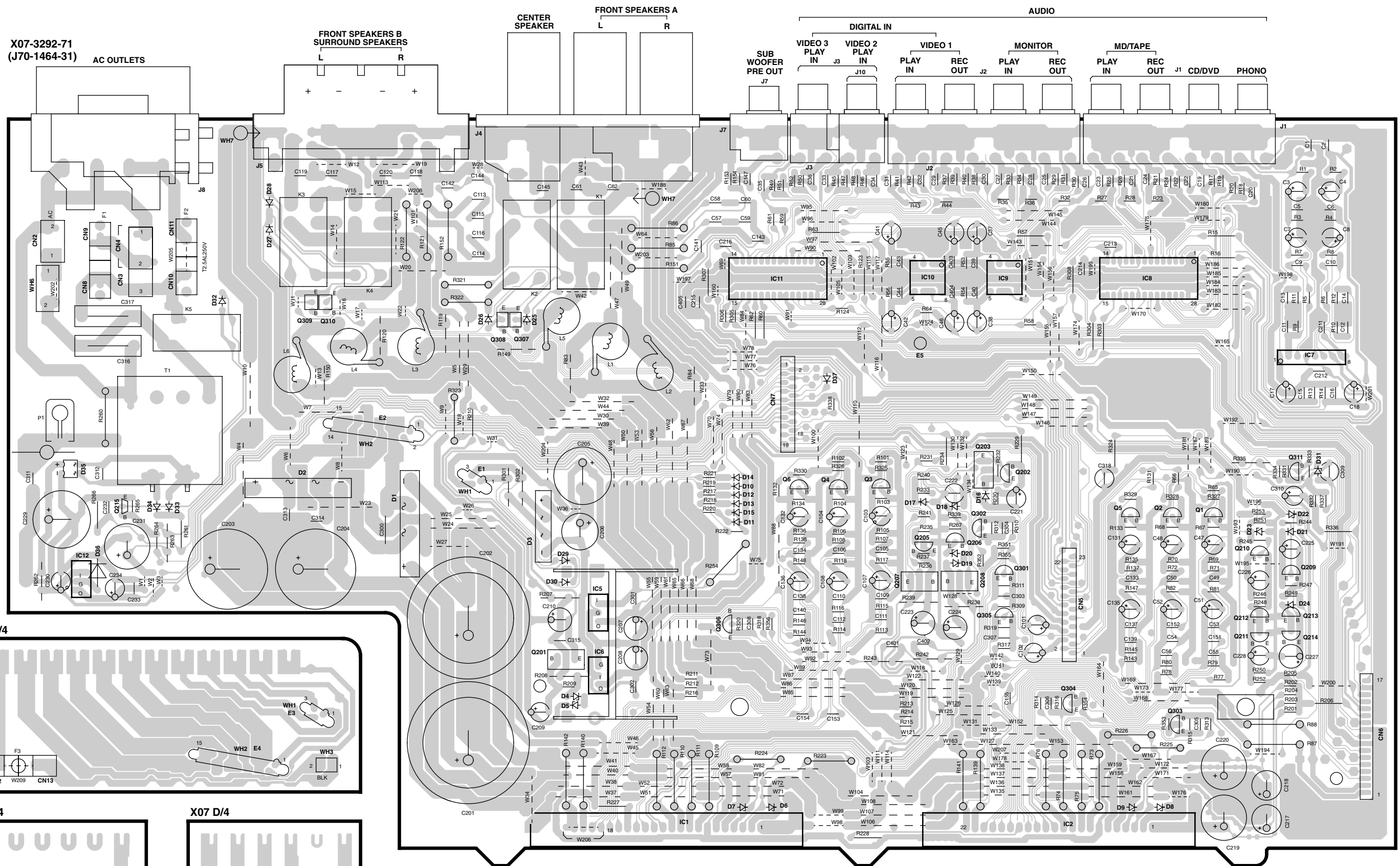

PC BOARD (Component side view)

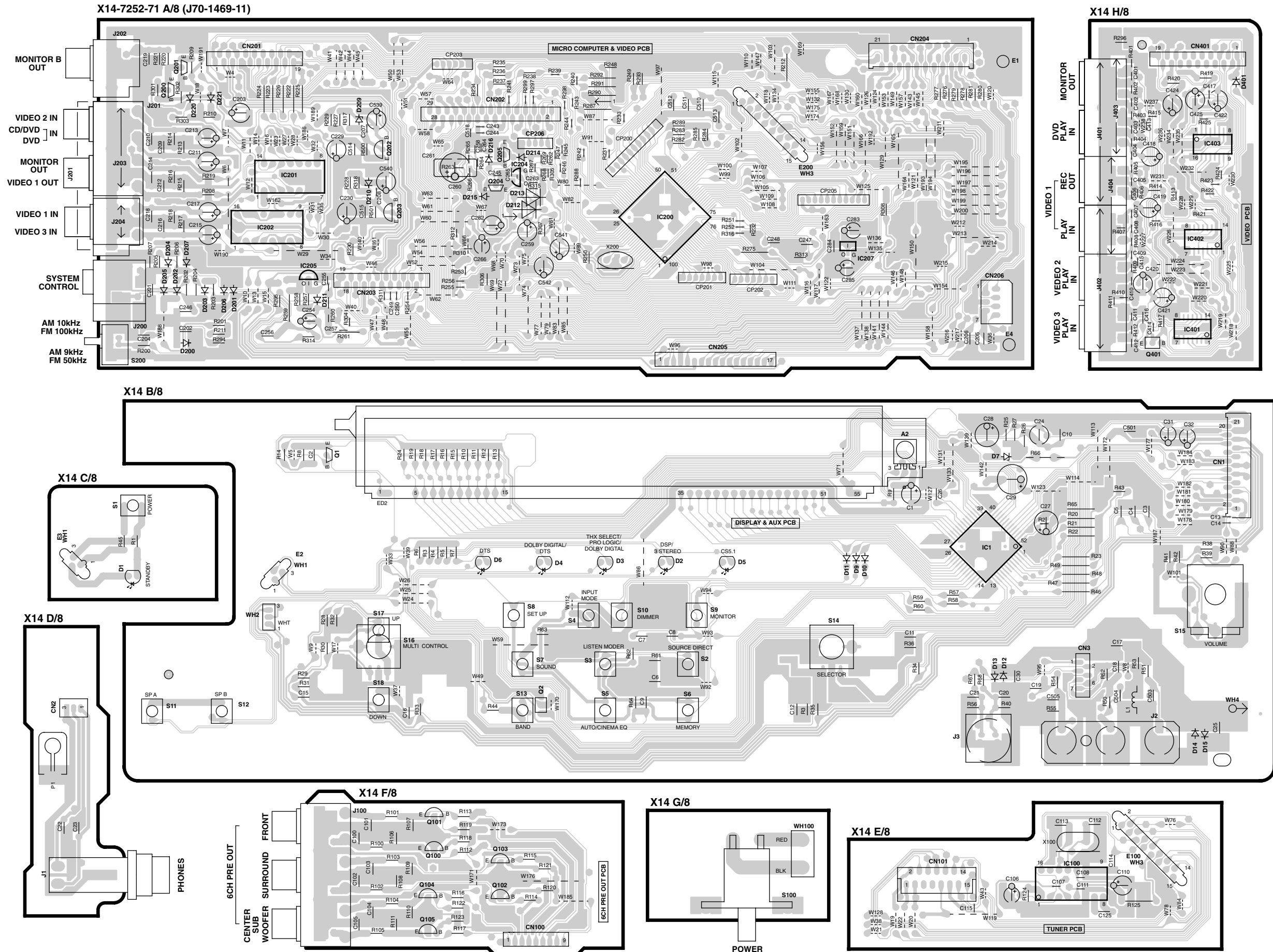

Refer to the schematic diagram for the value of resistors and capacitors.

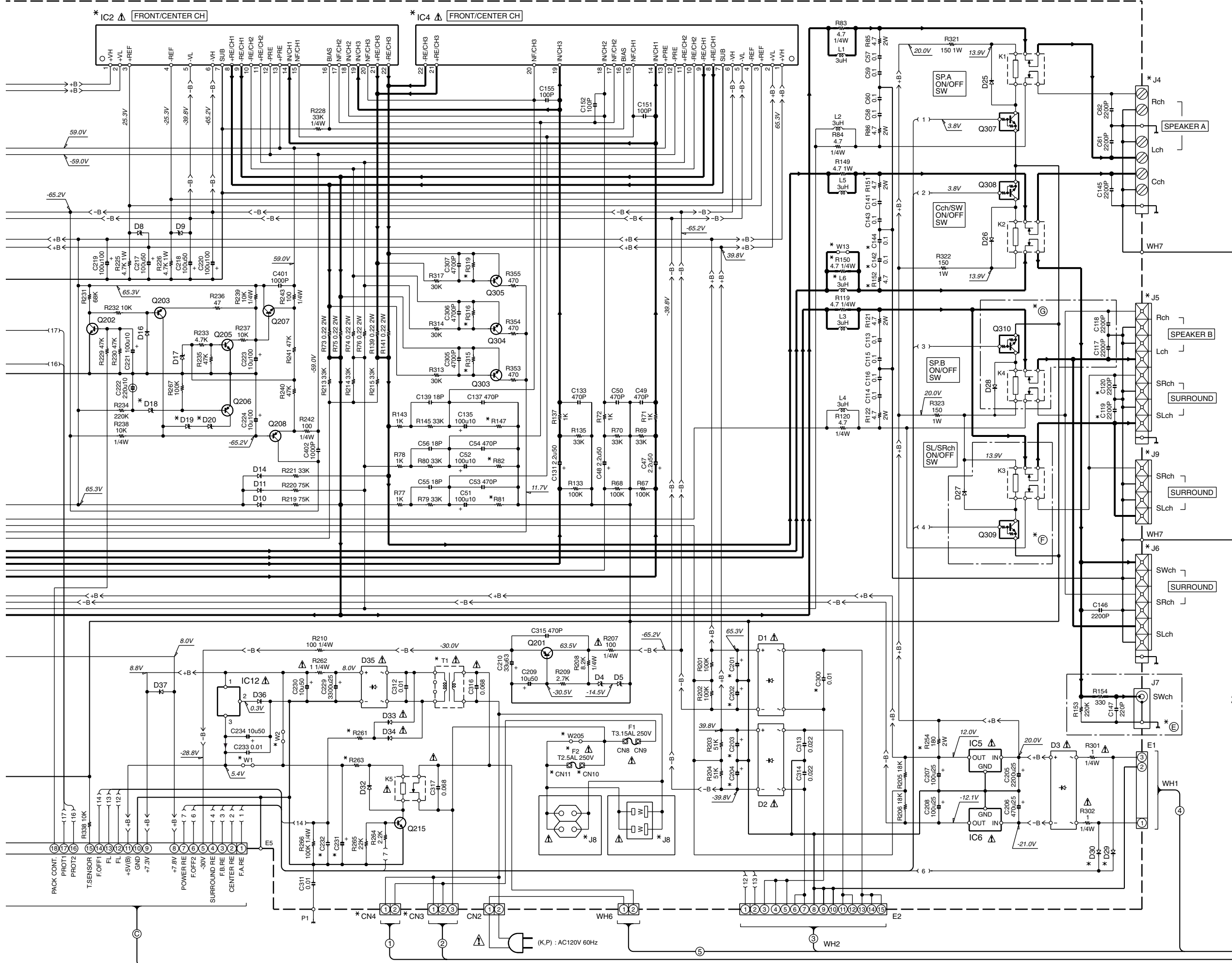

2SA1534A 2SC3940A
 2SA992 2SC1845
 2SC2878

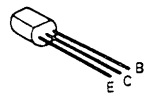

NJM4565D 2SC2785

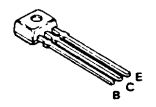
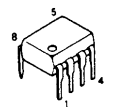

DTC124ESA
 2SC1740S

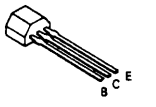

2SA1576A 2SD1819A
 2SB1218A

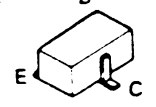

KTA1273 2SB1132

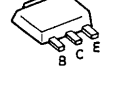
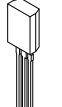

2SA1535A 2SC3944A

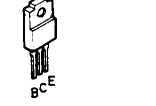

2SD1664 UN4212
 UN4219

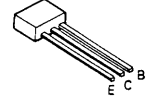
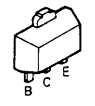

2SB1375 2SC4081

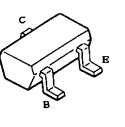

DESTINATION		UNIT No.	A	B	C	D	E	F	G	H	I	J	K	L	M	N	O	P	Q	R	S	T	U	V	W	X	Y	Z	AA	AB	AC	AD														
COUNTRY	ABB.																																													
KRF-X9050D-S (X07-329X-XX)																																														
U.K.	M	0-21	YES	NO	YES	NO	C90-3945-05	C90-3946-05	YES	0.033	1.2K	NO	YES	20K 1/4W	2.2 1/4W	9.1K	NO	MTZJ8.2(B) or RD8.2ES(B)	MTZJ15(B) or RD15ES(B)	MTZJ20(B) or RD20ES(B)	YES	YES	NO	NO	E70-0049-05	YES	NO	E03-0149-05	NO	YES	NO	NO	YES	STK412-040T or STK412-040N	STK413-040T	NO	NO	L07-2805-05	L07-2758-05							
EUROPE	I	2-71																																												
EUROPE	E	2-71																																												
EUROPE	Y	2-91																																												
KRF-X9050D (X07-329X-XX)																																														
U.K.	T	0-51	YES	NO	YES	NO	C90-3945-05	C90-3946-05	NO	0.047	1.2K	NO	YES	120K 1/4W	150 1/4W	9.1K	NO	MTZJ8.2(B) or RD8.2ES(B)	MTZJ16(B) or RD16ES(B)	MTZJ16(B) or RD16ES(B)	NO	NO	YES	NO	YES	E70-0049-05	YES	NO	E03-0310-05	NO	NO	YES	NO	YES	STK412-040T or STK412-040N	STK413-040T	NO	NO	L07-2761-05	L07-2805-05						
EUROPE	E	2-71																																												
EUROPE	Y	2-91																																												
KRF-V7050D-S (X07-3300-XX)																																														
U.K.	T	0-51	YES	NO	YES	NO	C90-3982-05	C90-3983-05	YES	0.033	1.1K	YES	NO	20K 1/4W	2.2 1/4W	10K	NO	MTZJ8.2(B) or RD8.2ES(B)	MTZJ16(B) or RD16ES(B)	MTZJ16(B) or RD16ES(B)	YES	YES	NO	NO	E70-0049-05	YES	NO	E03-0149-05	YES	YES	NO	YES	NO	YES	NO	YES	NO	STK412-020A	STK413-020A	NO	NO	L07-2805-05	L07-2758-05			
EUROPE	I	2-71																																												
EUROPE	Y	2-91																																												
KRF-V7050D (X07-3300-XX)																																														
U.K.	T	0-51	YES	NO	YES	NO	C90-3984-05	C90-3985-05	NO	0.047	1.2K	YES	NO	120K 1/4W	150 1/4W	10K	NO	MTZJ6.8(B) or RD6.8ES(B)	MTZJ16(B) or RD16ES(B)	MTZJ15(B) or RD15ES(B)	NO	NO	YES	NO	YES	E70-0049-05	YES	NO	E03-0310-05	NO	NO	YES	NO	YES	NO	YES	NO	YES	NO	STK412-020A	STK413-020A	NO	NO	L07-2761-05	L07-2805-05	
EUROPE	E	2-71																																												
EUROPE	Y	2-91																																												
KRF-V6050D (X07-3300-XX)																																														
U.K.	T	0-51	YES	NO	YES	NO	C90-3982-05	C90-3983-05	YES	0.033	1.1K	YES	NO	20K 1/4W	2.2 1/4W	10K	NO	MTZJ8.2(B) or RD8.2ES(B)	MTZJ16(B) or RD16ES(B)	MTZJ16(B) or RD16ES(B)	YES	YES	NO	NO	E70-0049-05	YES	NO	E03-0149-05	YES	YES	NO	YES	NO	YES	NO	YES	NO	YES	NO	STK412-020A	STK413-020A	NO	NO	L07-2805-05	L07-2758-05	
EUROPE	I	2-71																																												
EUROPE	Y	2-91																																												
KRF-V6050D-S (X07-3300-XX)																																														
U.K.	T	0-51	YES	NO	YES	NO	C90-3984-05	C90-3985-05	NO	0.047	1.2K	YES	NO	120K 1/4W	150 1/4W	10K	NO	MTZJ6.8(B) or RD6.8ES(B)	MTZJ16(B) or RD16ES(B)	MTZJ15(B) or RD15ES(B)	NO	NO	YES	NO	YES	E70-0122-05	NO	NO	E03-0310-05	NO	NO	YES	NO	YES	NO	YES	NO	YES	NO	STK412-020A	STK413-020A	NO	NO	L07-2761-05	L07-2805-05	
EUROPE	E	2-71																																												
EUROPE	Y	2-91																																												
KRF-V5050D (X07-3300-XX)																																														
U.K.	T	0-51	YES	NO	YES	NO	C90-3984-05	C90-3985-05	NO	0.047	1.2K	YES	NO	120K 1/4W	150 1/4W	10K	NO	MTZJ6.8(B) or RD6.8ES(B)	MTZJ16(B) or RD16ES(B)	MTZJ15(B) or RD15ES(B)	NO	NO	YES	NO	YES	E70-0122-05	NO	NO	E03-0310-05	NO	NO	YES	NO	YES	NO	YES	NO	YES	NO	STK412-020A	STK413-020A	NO	NO	L07-2761-05	L07-2805-05	
EUROPE	E	2-71																																												
EUROPE	Y	2-91																																												
KRF-V5050D-S (X07-331X-XX)																																														
U.K.	T	0-51	YES	NO	YES	NO	C90-3982-05	C90-3983-05	YES	0.033	1.1K	YES	NO	20K 1/4W	2.2 1/4W	10K	NO	MTZJ8.2(B) or RD8.2ES(B)	MTZJ16(B) or RD16ES(B)	MTZJ16(B) or RD16ES(B)	YES	YES	NO	NO	E70-0122-05	NO	NO	E03-0149-05	YES	YES	NO	YES	NO	YES	NO	YES	NO	YES	NO	STK412-020A	STK413-020A	NO	NO	L07-2805-05	L07-2758-05	
EUROPE	I	2-71																																												
EUROPE	Y	2-91																																												
KRF-V5050D-S (X07-331X-XX)																																														
U.K.	T	0-51	YES	NO	YES	NO	C90-3984-05	C90-3985-05	NO	0.047	1.2K	YES	NO	120K 1/4W	150 1/4W	10K	NO	MTZJ6.8(B) or RD6.8ES(B)	MTZJ16(B) or RD16ES(B)	MTZJ15(B) or RD15ES(B)	NO	NO	YES	NO	YES	E70-0122-05	NO	NO	E03-0310-05	NO	NO	YES	NO	YES	NO	YES	NO	YES	NO	STK412-020A	STK413-020A	NO	NO	L07-2761-05	L07-2805-05	
EUROPE	E	2-71																																												
EUROPE	Y	2-91																																												
KRF-V5050D-E (X07-3312-71)																																														
U.K.	T	0-51	YES	NO	YES	NO	C90-3984-05	C90-3985-05	NO	0.047	1.2K	YES	NO	120K 1/4W	150 1/4W	10K	NO	MTZJ6.8(B) or RD6.8ES(B)	MTZJ16(B) or RD16ES(B)	MTZJ15(B) or RD15ES(B)	NO	NO	YES	NO	YES	E70-0122-05	NO	NO	E03-0149-05	YES	YES	NO	YES	NO	YES	NO	YES	NO	YES	NO	STK412-020A	STK413-020A	NO	NO	L07-2761-05	L07-2805-05
EUROPE	E	2-71																																												
KRF-V5550D-S (X07-333X-XX)																																														
U.K.	T	0-21	NO	YES	NO	YES	C90-3984-05	C90-3985-05	0.033	1.2K	YES	NO	20K 1/4W	2.2 1/4W	10K	YES	MTZJ6.8(B) or RD6.8ES(B)	MTZJ15(B) or RD15ES(B)	MTZJ13(B) or RD13ES(B)	YES	NO	NO	NO	E70-0122-05	NO	YES	E03-0149-05	YES	YES	NO	NO	NO	NO	NO	NO	NO	NO	NO	NO	NO	NO	NO	NO	NO	L07-2805-05	L07-2805-05
EUROPE	I	2-71																																												
EUROPE	Y	2-91																																												

TC7WH123FU

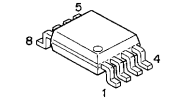

S-80840ANY

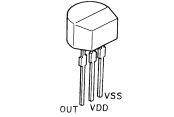

TC7WU04FU

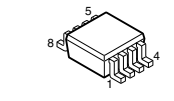

BA05T

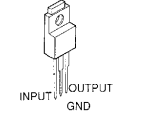

KIA7812API

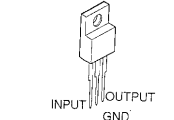

CAUTION: For continued safety, replace safety critical components only with manufacturer's recommended parts (refer to parts list). Δ indicates safety critical components. For continued protection against risk of fire, replace only with same type and rating fuse(s). To reduce the risk of electric shock, leakage-current or resistance measurements shall be carried out (exposed parts are acceptably insulated from the supply circuit) before the appliance is returned to the customer.

The DC voltage is an actual reading measured with a high impedance type voltmeter with no signal input. The measurement value may vary depending on the measuring instruments used or on the product.

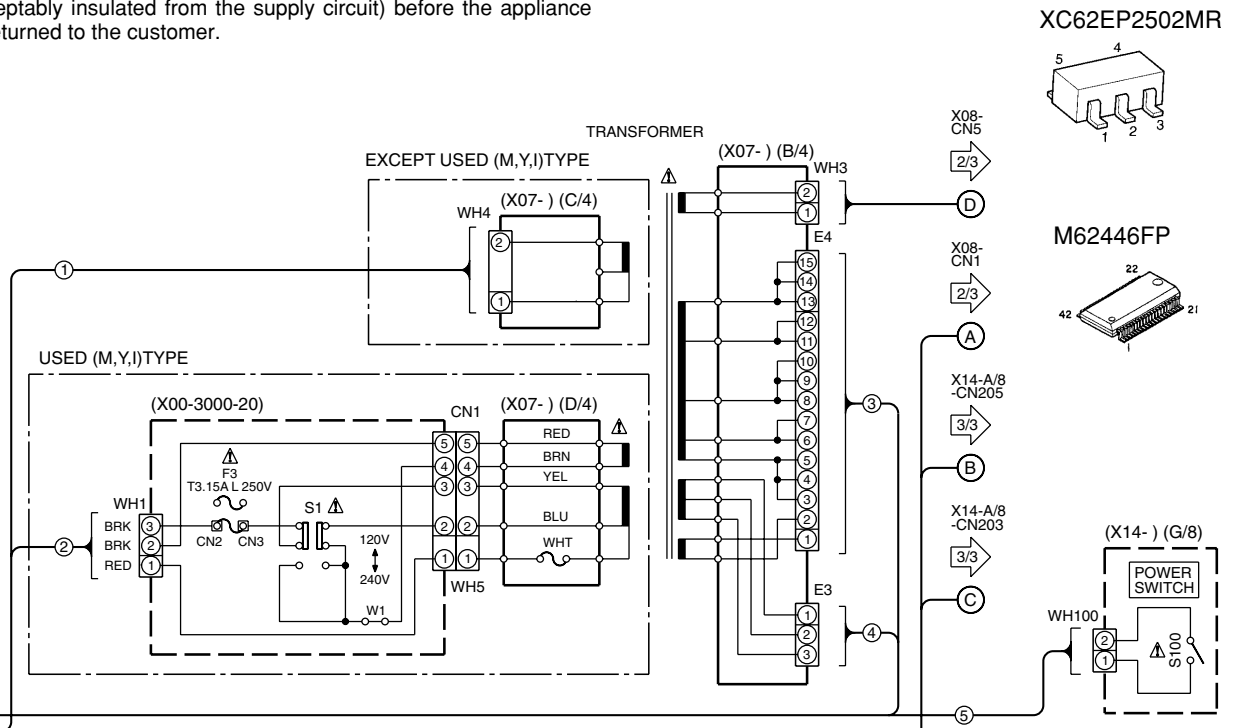

Component	Part Number	Notes
IC1	*	DIGITAL LINE
IC2	*	SIGNAL LINE
IC3,4	*	GND LINE
IC5	KIA7812API	+B LINE
IC6	KIA7912PI	-B LINE
IC7	NJM4580L-D	
IC8,11	NJU7313AL	
IC9,10	NJU4565D	
IC12	BA05T	
Q1-6	2SC2878(B)	
Q201,208	2SB1640	
Q202,205,211-214,301-306	2SC1845(F,E)	
Q203	2SA1535A	
Q206,209,210,311	2SA992(F,E)	
Q207	2SC3944A	
Q215	2SC1740S(Q,R) or 2SC2785(F,E)	
Q307-310	UN4219	
D1	TS6P03G-B or D5SB20F03	
D2	TS10P03G-B	
D3	D2SBA20F03	
D4	MTZJ16(B) or RD16ES(B)	
D5-9	MTZJ15(B) or RD15ES(B)	
D10-17,21,24-30,32-34	1SS133 or HSS104A	
D18	*	
D19	*	
D20	*	
D22,23,31	MTZJ3.9(B) or RD3.9ES(B)	
D35	S1ZB20 (4101)	
D36	RB721Q	
XC62EP2502MR		
M62446FP		
NJU7311AM		
KIA7912PI		
DTA124EUA DTC124EUA		
NJM2279D		
TC74HC07AF		
NJU4052BD		
TC74HC4052AP		
NJM4580L-D		
NJM4565M NJM4565MD		
UPD16311		
DAN202U		
DAP202U		
MA142WA UN5212		
MA142WK		
NJU7313AL		
XC62FP5102P		
1SS301		
TC74HCT7007AF		
NJM2279M		

KRF-V5050D/V5550D/V6050D/V7050D/X9050D

Y05-4152-71

KENWOOD

X07-A/4
-CN5
1/3
A

X07-B/4
-WH3
1/3
D

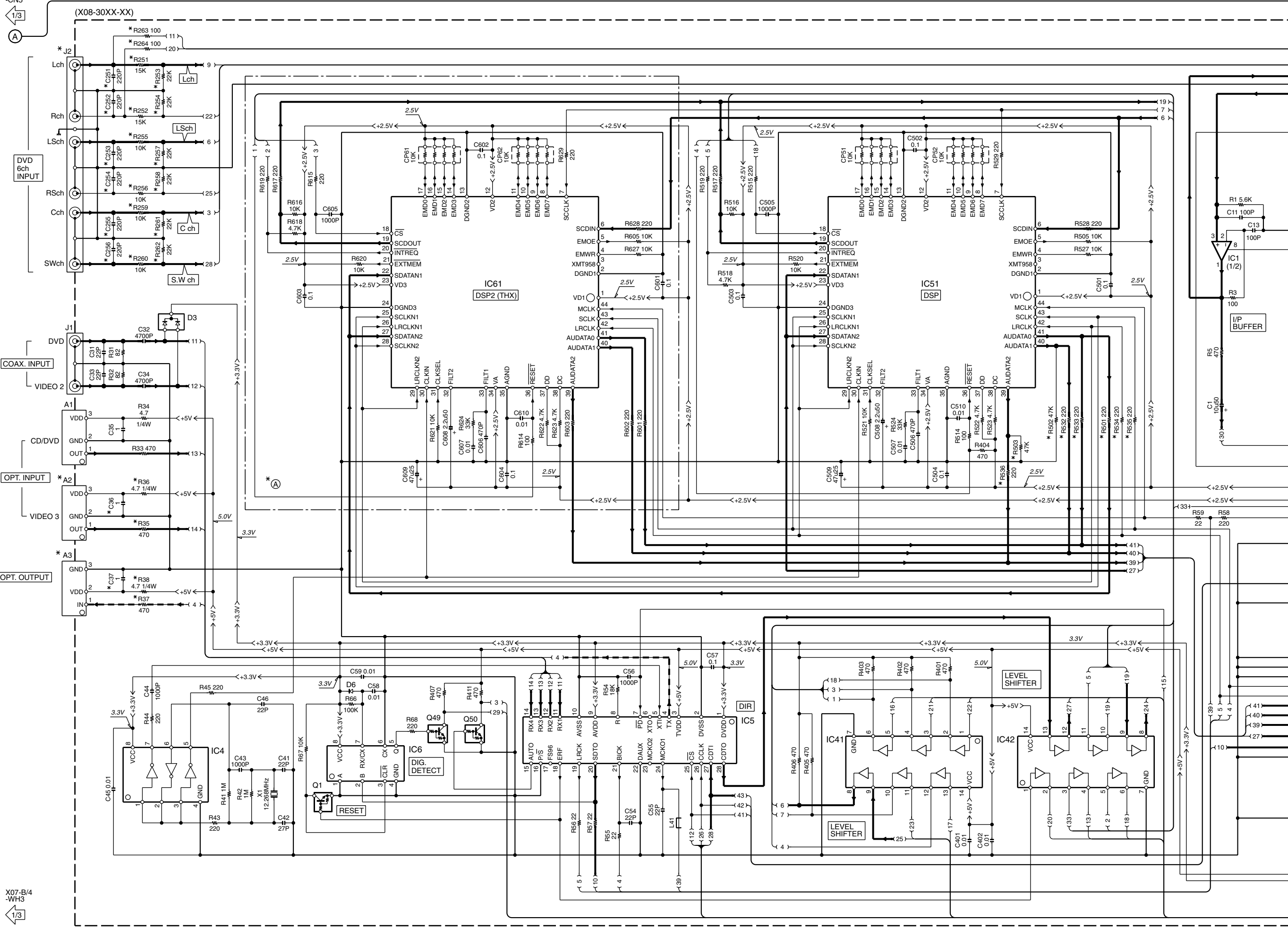

2

3

4

5

6

7

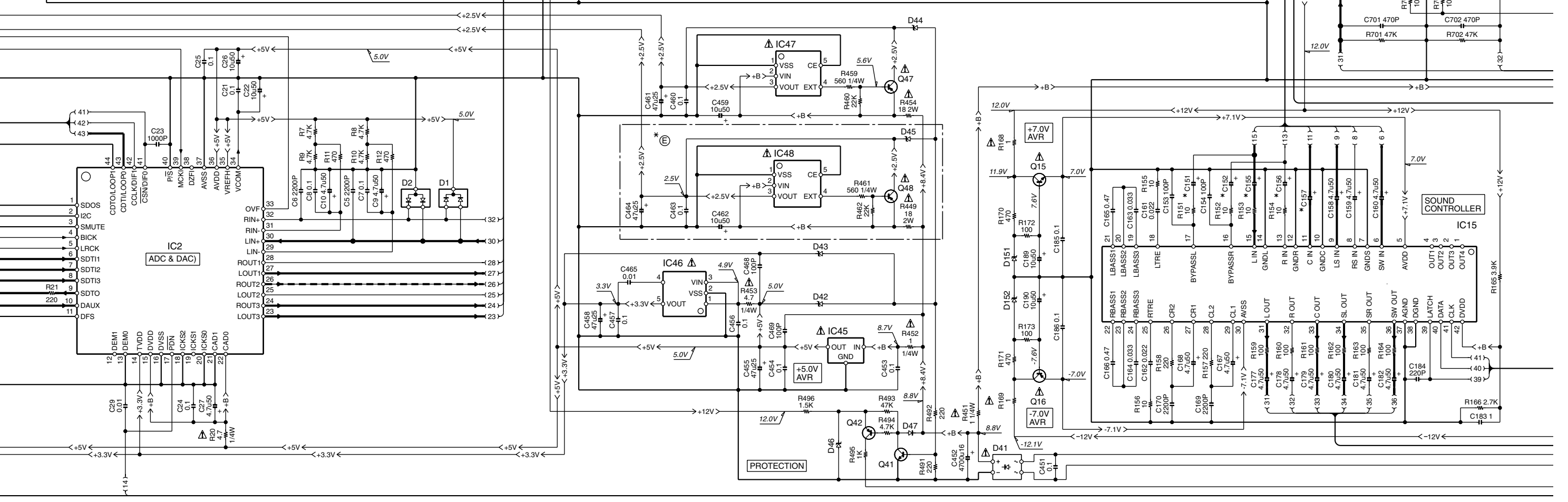
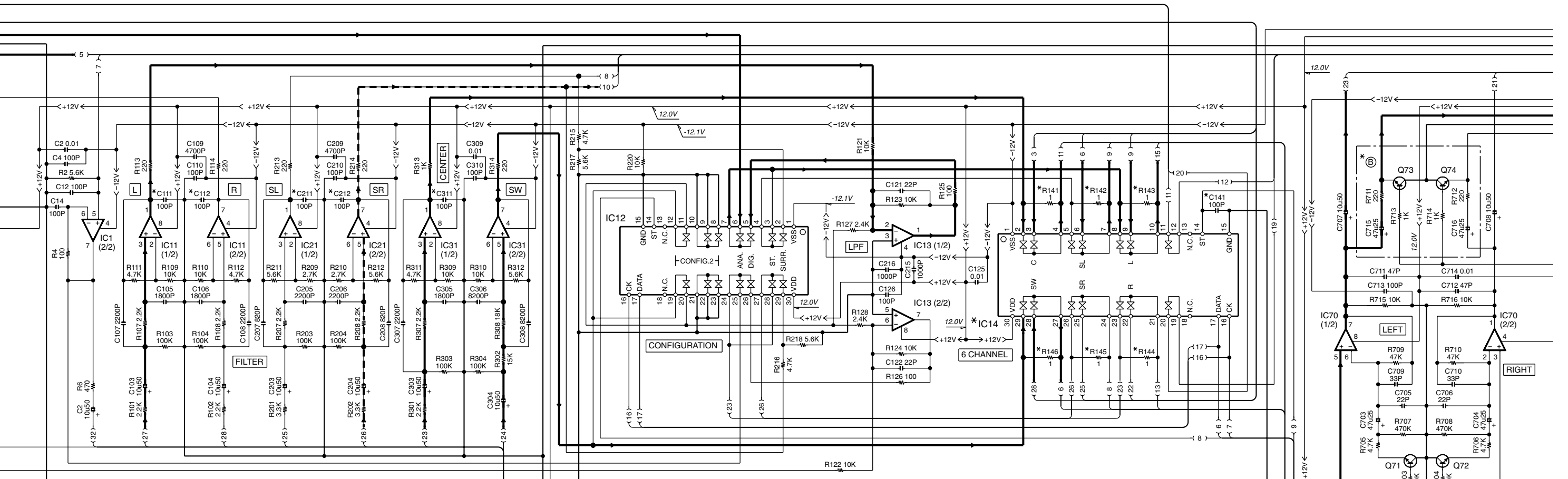

(X08-30XX-XX)

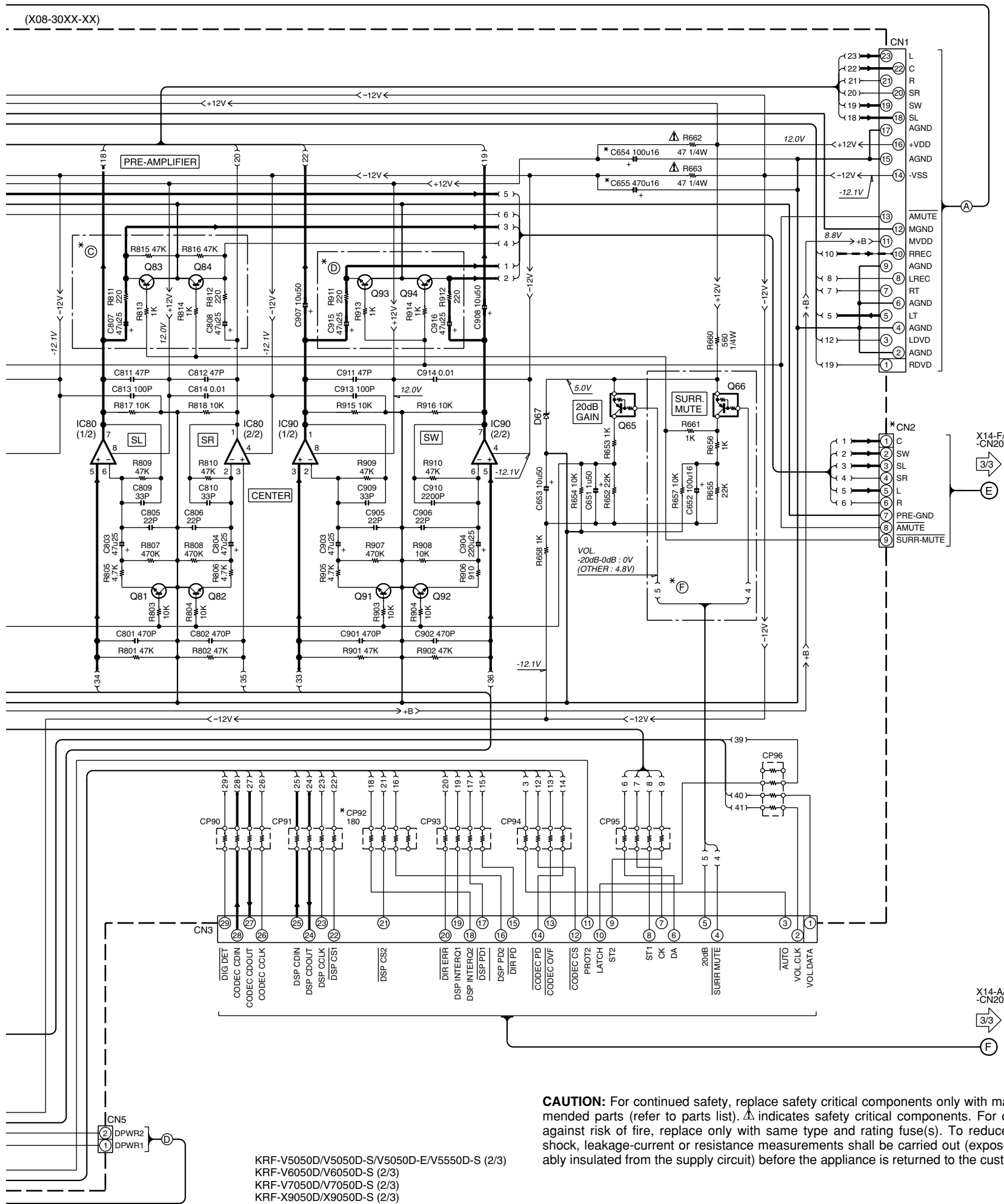

KRF-V5050D/V5050D-S/V5050D-E/V5550D-S (2/3)
 KRF-V6050D/V6050D-S (2/3)
 KRF-V7050D/V7050D-S (2/3)
 KRF-X9050D/X9050D-S (2/3)

CAUTION: For continued safety, replace safety critical components only with manufacturer's recommended parts (refer to parts list). Δ indicates safety critical components. For continued protection against risk of fire, replace only with same type and rating fuse(s). To reduce the risk of electric shock, leakage-current or resistance measurements shall be carried out (exposed parts are acceptably insulated from the supply circuit) before the appliance is returned to the customer.

DESTINATION		UNIT No.	A	B	C	D	E	F	A2	A3	C36,37,111,112,141,211,212,251-256,311,654,655	C151,152,155-157	R35-38,251-264,501-503	R141-146,532-536	IC14	J2	CP92	CN2
COUNTRY	ABB.																	
PX	Y																	
EUROPE	E	0-14									YES		YES		YES	YES	YES	YES
U.K.	T																	

DESTINATION		UNIT No.	A	B	C	D	E	F	A2	A3	C36,37,111,112,141,211,212,251-256,311,654,655	C151,152,155-157	R35-38,251-264,501-503	R141-146,532-536	IC14	J2	CP92	CN2
COUNTRY	ABB.																	
PX	Y																	
EUROPE	E	0-14									YES		YES		YES	YES	YES	YES
U.K.	T																	

DESTINATION		UNIT No.	A	B	C	D	E	F	A2	A3	C36,37,111,112,141,211,212,311,251-256	C151,152,155-157	C37,654,655	R35,36,251-264,532-536	R37,38,141-146,501-503	IC14	J2	CP92	CN2
COUNTRY	ABB.																		
PX	Y																		
EUROPE	E	0-12									YES	NO	YES		NO		YES	YES	
U.K.	T																		

DESTINATION		UNIT No.	A	B	C	D	E	F	A2	A3	C36,37,111,112,141,211,212,311,251-256	C151,152,155-157	C37,654,655	R35,36,251-264,532-536	R37,38,141-146,501-503	IC14	J2	CP92	CN2
COUNTRY	ABB.																		
PX	Y																		
EUROPE	E	0-12									YES	NO	YES		NO		YES	YES	
U.K.	T																		

DESTINATION		UNIT No.	A	B	C	D	E	F	A2	A3	C36,37,111,112,211,212,311,654,655	C141,251-256	C151,152,155-157	R35-38,141-146,501-503	R251-264,532-536	IC14	J2	CP92	CN2
COUNTRY	ABB.																		
PX	Y																		
EUROPE	E	0-11									NO	NO	YES		NO		YES	YES	

DESTINATION		UNIT No.	A	B	C	D	E	F	A2	A3	C36,37,111,112,211,212,311,654,655	C141,251-256	C151,152,155-157	R35-38,141-146,501-503	R251-264,532-536	IC14	J2	CP92	CN2
COUNTRY	ABB.																		
PX	Y																		
EUROPE	E	0-11									NO	NO	YES		NO		YES	YES	

DESTINATION		UNIT No.	A	B	C	D	E	F	A2	A3	C36,37,111,112,211,212,311,654,655	C141,251-256	C151,152,155-157	R35-38,141-146,501-503	R251-264,532-536	IC14	J2	CP92	CN2
COUNTRY	ABB.																		
PX	Y																		
EUROPE	E	0-11									NO	NO	YES		NO		YES	YES	
U.K.	T																		

DESTINATION		UNIT No.	A	B	C	D	E	F	A2	A3	C36,37,111,112,211,212,311,654,655	C141,251-256	C151,152,155-157	R35-38,141-146,501-503	R251-264,532-536	IC14	J2	CP92	CN2
COUNTRY	ABB.																		
PX	Y																		
EUROPE	E	0-11									NO	NO	YES		NO		YES	YES	
U.K.	T																		

DESTINATION		UNIT No.	A	B	C	D	E	F	A2	A3	C36,37,111,112,211,212,311,654,655	C141,251-256	C151,152,155-157	R35-38,141-146,501-503	R251-264,532-536	IC14	J2	CP92	CN2
COUNTRY	ABB.																		
PX	Y																		
EUROPE	E	0-11									NO	NO	YES		NO		YES	YES	
U.K.	T																		

DESTINATION		UNIT No.	A	B	C	D	E	F	A2	A3	C36,37,111,112,211,212,311,654,655	C151,152,155-157	R35-38,251-264,501-503	R141-146,532-536	IC14	J2	CP92	CN2
COUNTRY	ABB.																	
PX	Y																	
EUROPE	E	0-10									NO	NO	YES		NO		NO	NO
U.K.	T																	

- IC1,11,13,21,31,70,80,90 : NJM4565M or NJM4565MD
- IC2 : AK4527B-VQ
- IC4 : TC7WU04FU
- IC5 : AK4112AVF
- IC6 : TC7WH123FU
- IC12,14 : NJU7311AM
- IC15 : M6244FP
- IC41 : TC74HC07AF
- IC42 : TC74HCT7007AF
- IC45 : BAO5T
- IC46 : BA033LBSG
- IC47,48 : XC62EP2502MR
- IC51 : CS493263-CLR
- IC61 : CS493302-CLR
- Q1,49,50 : UN5212 or DTC124EUA
- Q15 : 2SD1664(Q,R)
- Q16 : 2SB1132(Q,R)
- Q41 : 2SC4081(R,S) or 2SD1819A(Q,R)
- Q42 : 2SA1576A(R,S) or 2SB1218A(Q,R)
- Q47,48 : M6244FP
- Q65,66 : UN5112 or DTA124EUA
- Q71-74,81-84,91-94 : 2SC4213 (B)
- D1,3 : 1SS301 or DAN202U or MA142WK
- D2 : 1SS300 or DAF202U or MA142WA
- D6,47 : MA111
- D41 : D2SBA20F03
- D42,43 : UD25.6B or HZU5.6 (B2)
- D44,45 : UD23.9B or HZU3.9 (B2)
- D46,67 : UD25.1B or HZU5.1 (B2)
- D151,152 : UDZ7.5B or HZU7.5 (B2)

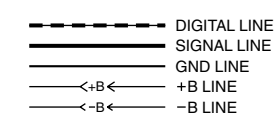

The DC voltage is an actual reading measured with a high impedance type voltmeter with no signal input. The measurement value may vary depending on the measuring instruments used or on the product.

KRF-V5050D/V5550D/V6050D/V7050D/X9050D

(X14-7XXX-XX) (H/8)
 IC401,402 : NJM2279M
 IC403 : TC74HC4052AF
 Q401 : UN4212 or DTC124ESA
 D401 : 1SS133 or HSS104A

(X14-7XXX-XX) (H/8)

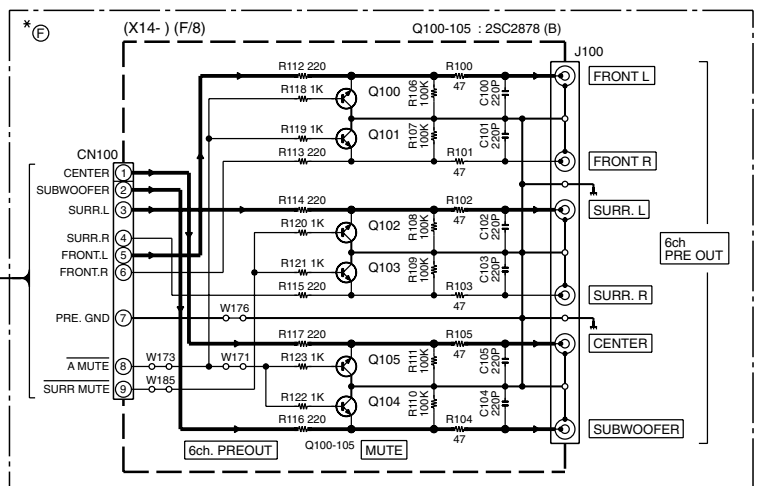
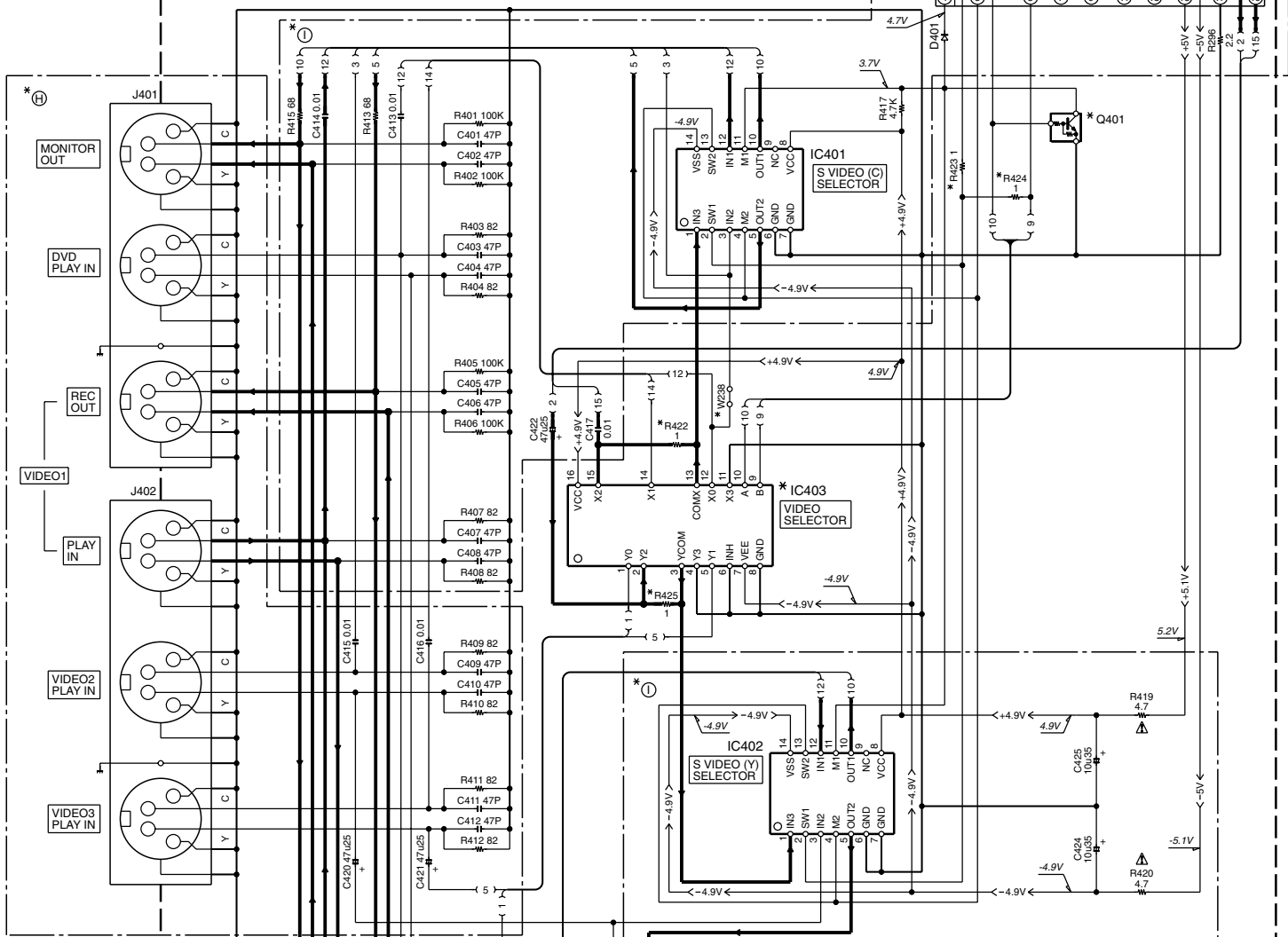

(X14-7XXX-XX) (A/8)

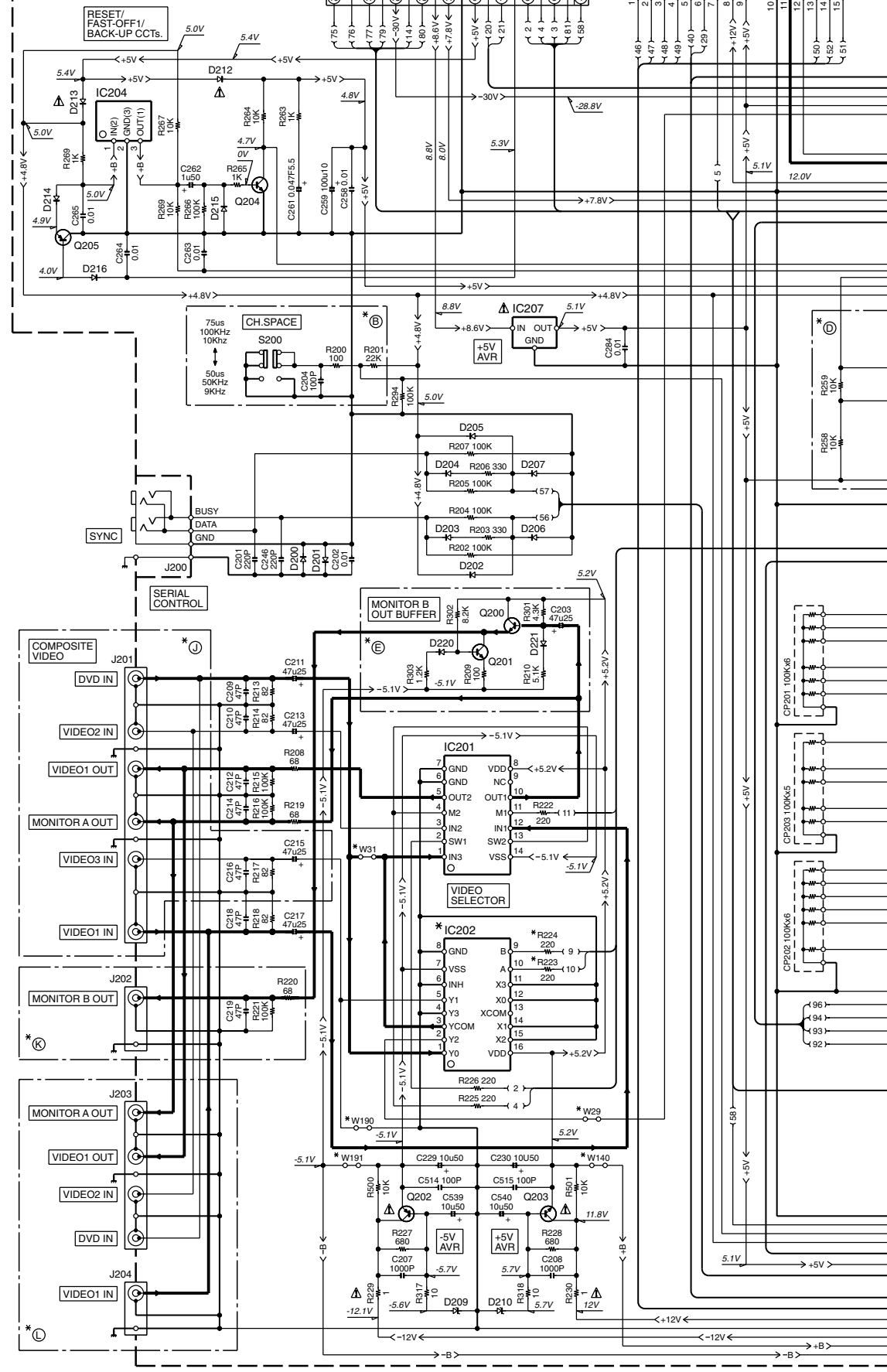

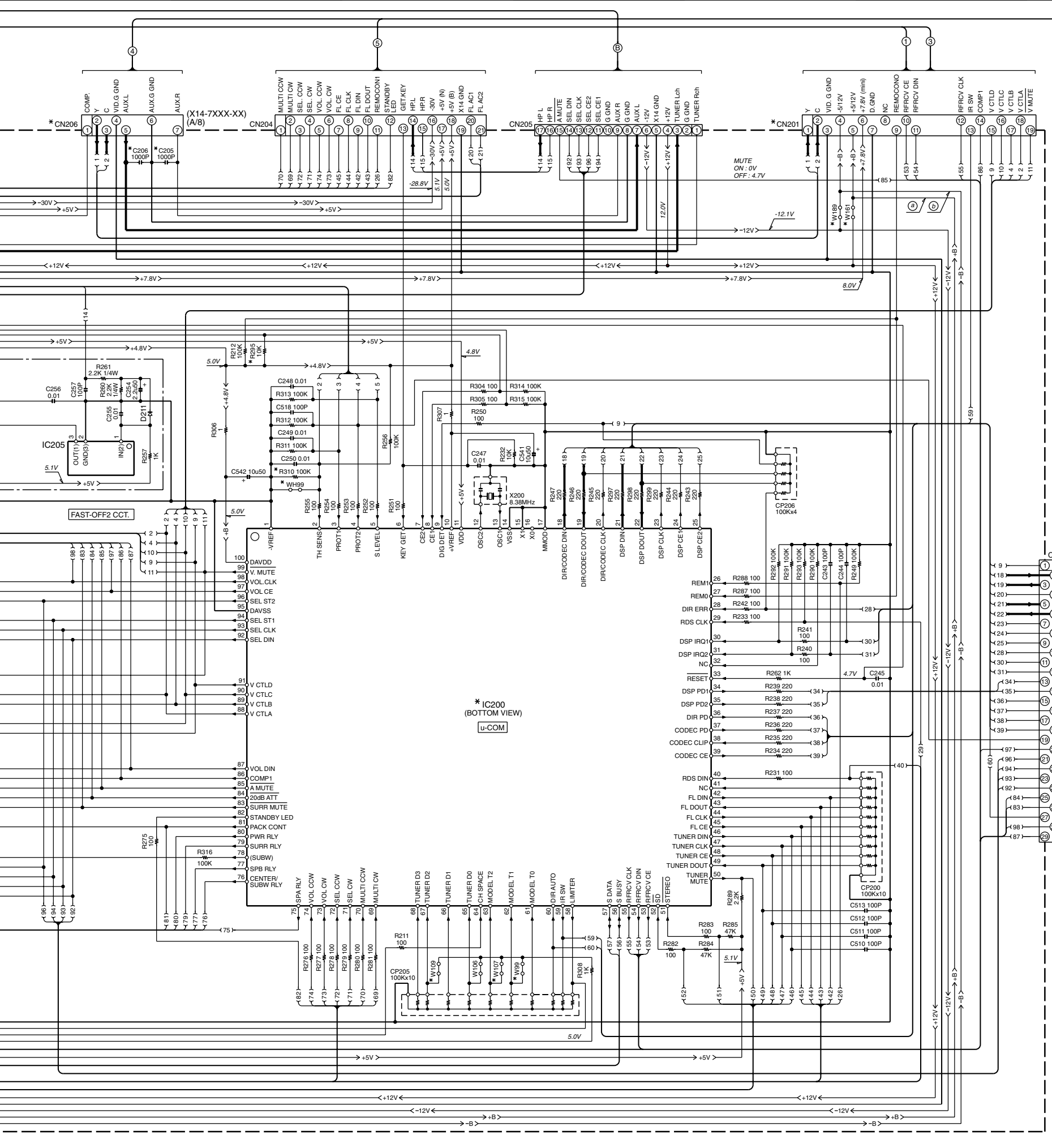

(X14-7XXX-XX) (B/B)

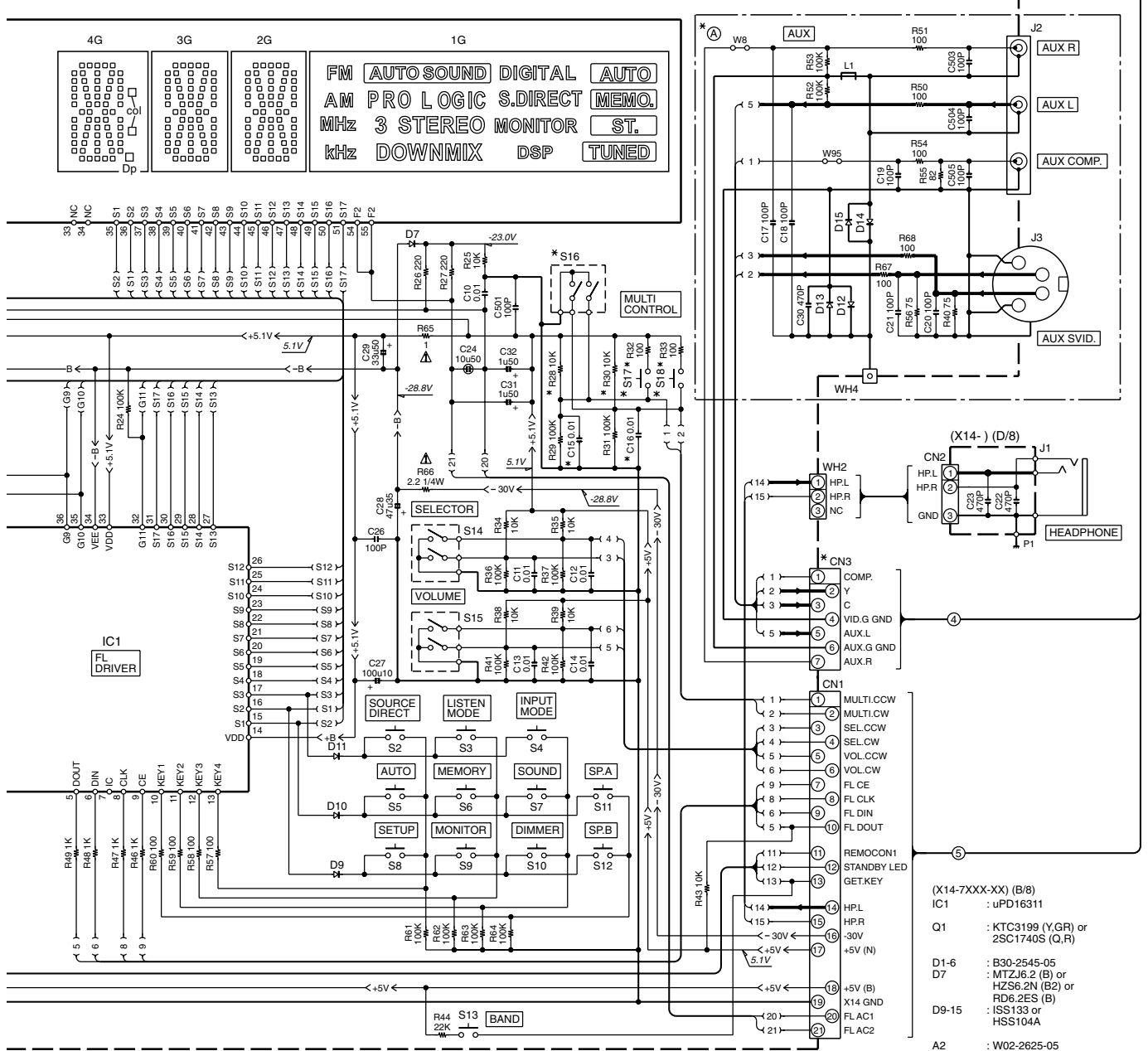

- (X14-7XXX-XX) (B/B)
- IC1 : uPD16311
- Q1 : KTC3199 (Y,G,R) or 2SC1740S (Q,R)
- D1-6 : B30-2545-05
D7 : MTZ16.2 (B) or HZS6.2N (B2) or RD6.2ES (B)
- D9-15 : ISS133 or HSS104A
- A2 : W02-2625-05
- ED2 : HNA-11MS24 or 11-MT-125GK

	11G	10G	9G	8G	7G	6G	5G	4G	3G	2G	1G
P1	SP	D	L	a	a	a	a	a	a	a	FM
P2	A	C	i	j	j	j	j	j	j	j	AM
P3	B	R	h	h	h	h	h	h	h	h	MHz
P4	TL VOL	SL	k	k	k	k	k	k	k	k	kHz
P5	CLIP	S	b	b	b	b	b	b	b	b	AUTO
P6	-	SR	f	f	f	f	f	f	f	f	MEMO
P7	-	LFE	g	g	g	g	g	g	g	g	ST.
P8	MUTE	SW	m	m	m	m	m	m	m	m	TUNED
P9	RDS	(L)	c	c	c	c	c	c	c	c	AUDIO SOUND
P10	EON	(C)	e	e	e	e	e	e	e	e	PRO LOGIC
P11	PTY	(R)	r	r	r	r	r	r	r	r	3
P12	TP	(SL)	n	n	n	n	n	n	n	n	STEREO
P13	TA	(S)	p	p	p	p	p	p	p	p	DOWNMIX
P14	NEWS	(SR)	d	d	d	d	d	d	d	d	DIGITAL
P15	-	-	-	-	-	-	-	ool	-	-	S.DIRECT
P16	-	-	-	-	-	-	-	-	Dp	-	MONITOR
P17	-	-	-	-	-	-	-	-	-	-	DSP

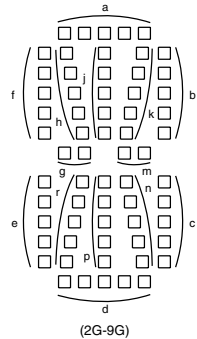

- DIGITAL LINE
- SIGNAL LINE
- GND LINE
- ←+B← +B LINE
- ←-B← -B LINE

KRF-V5050D/V5550D/V6050D/V7050D/X9050D

* New Parts
Parts without **Parts No.** are not supplied.
Les articles non mentionnés dans le **Parts No.** ne sont pas fournis.
Teile ohne **Parts No.** werden nicht geliefert.

①

Ref. No	Add-ress	New Parts	Parts No.	Description	Desti-nation	Re-marks
KRF-V5050D/V5050DE/V5050D-S						
601	1A	*	A01-3795-01	METALLIC CABINET	YETE2	
601	1A	*	A01-3796-01	METALLIC CABINET	E3T2	
601	1A	*	A01-3796-01	METALLIC CABINET	MXI	
602	1A	*	A09-1178-08	BATTERY COVER		
605	2B	*	A60-1933-01	PANEL	E3T2	
605	2B	*	A60-1933-01	PANEL	MXI	
605	2B	*	A60-1934-01	PANEL	YETE2	
606	1A	*	A70-1468-15	REMOTE CONTROL ASSY RC-R0511	YMXI	
606	1A	*	A70-1469-05	REMOTE CONTROL ASSY RC-R0512	ETE2	
606	1A	*	A70-1469-05	REMOTE CONTROL ASSY RC-R0512	E3T2	
610	2A	*	B07-2550-02	ESCUTCHEON	YETE2	
610	2A	*	B07-2551-02	ESCUTCHEON	E3T2	
610	2A	*	B07-2551-02	ESCUTCHEON	MXI	
611	2A	*	B10-3658-02	FRONT GLASS	YMXI	
611	2A	*	B10-3670-02	FRONT GLASS	ETE2	
611	2A	*	B10-3670-02	FRONT GLASS	E3T2	
613	2B	*	B12-0384-04	INDICATOR		
614	2B	*	B12-0385-04	INDICATOR		
615	2A	*	B43-0314-04	KENWOOD BADGE		
-	-	-	B46-0096-53	WARRANTY CARD	X	
-	-	-	B46-0310-03	WARRANTY CARD	ETE2	
-	-	-	B46-0310-03	WARRANTY CARD	E3T2	
-	-	-	B46-0328-03	WARRANTY CARD	Y	
-	-	-	B58-0513-04	CAUTION CARD (PRESET220-240)	Y	
-	-	-	B58-0945-03	CAUTION CARD	TT2	
-	-	-	B58-0964-13	CAUTION CARD (UL)	Y	
-	-	-	B58-0965-13	CAUTION CARD (T.XtypePL)	XTT2	
-	-	-	B58-0966-13	CAUTION CARD (ELMtypePL)	MIEE3	
-	-	-	B58-1607-03	CAUTION CARD	E2	
-	-	-	B59-1104-00	SERVICE DIRECTORY	Y	
-	-	*	B60-4942-00	INSTRUCTION MANUAL (EN)	YMXI	
-	-	*	B60-4944-00	INSTRUCTION MANUAL (ES)	M	
-	-	*	B60-4945-00	INSTRUCTION MANUAL (TC)	MI	
-	-	*	B60-4947-00	INSTRUCTION MANUAL (EN)	TE2T2	
-	-	*	B60-4948-00	INSTRUCTION MANUAL (FR/GE)	EE3	
-	-	*	B60-4949-00	INSTRUCTION MANUAL (NE/IT)	EE3	
-	-	*	B60-4950-00	INSTRUCTION MANUAL (ES)	EE3	
-	-	*	B60-4951-00	INSTRUCTION MANUAL (PL/RU)	E2	
-	-	*	B60-4952-00	INSTRUCTION MANUAL (CZ/HU)	E2	
△ 619	1A	*	E03-0115-05	AC PLUG ADAPTER	M	
△ 620	1C	*	E30-2605-05	AC POWER CORD	Y	
△ 620	1C	*	E30-2717-05	AC POWER CORD	X	
△ 620	1C	*	E30-2721-05	AC POWER CORD	TT2	
△ 620	1C	*	E30-2942-05	AC POWER CORD	E2E3	
△ 620	1C	*	E30-2942-05	AC POWER CORD	MIE	
621	2B,2C	*	E35-2774-15	FLAT CABLE 21P		
623	1C,2C	*	E35-2776-05	FLAT CABLE 29P		
624	1C	*	E35-2777-05	FLAT CABLE 23P		
625	1C,2C	*	E35-2841-05	FLAT CABLE 19P		
-	-	*	H10-7743-02	POLYSTYRENE FOAMED FIXTURE		
-	-	*	H10-7744-02	POLYSTYRENE FOAMED FIXTURE		
-	-	*	H25-0232-04	PROTECTION BAG (235X350X0.03)		
-	-	*	H25-0391-04	PROTECTION BAG		

L : Scandinavia K : USA P : Canada R : Mexico C : China I : Malaysia
Y : PX(Far East,Hawaii) T : England E : Europe G : Germany V : China(Shanghai)
Y : AAFES(Europe) X : Australia Q : Russia H : Korea M : Other Areas △ indicates safety critical components.

* New Parts
Parts without **Parts No.** are not supplied.
Les articles non mentionnés dans le **Parts No.** ne sont pas fournis.
Teile ohne **Parts No.** werden nicht geliefert.

②

Ref. No	Add-ress	New Parts	Parts No.	Description	Desti-nation	Re-marks
-	-	*	H50-3998-04	ITEM CARTON CASE	YT	
-	-	*	H50-3999-04	ITEM CARTON CASE	X	
-	-	*	H50-4000-04	ITEM CARTON CASE	MI	
-	-	*	H50-4001-04	ITEM CARTON CASE	E	
-	-	*	H50-4002-04	ITEM CARTON CASE	E2	
-	-	*	H50-4003-04	ITEM CARTON CASE	E3	
-	-	*	H50-4004-04	ITEM CARTON CASE	T2	
641	2B,2C	*	J02-1464-03	FOOT		
642	2B,2C	*	J19-3751-04	UNIT HOLDER		
643	1C	*	J19-6078-05	UNIT HOLDER		
△ 647	1C	*	J42-0083-05	POWER CORD BUSHING		
-	-	*	J61-0307-05	WIRE BAND		
650	2B	*	K29-7675-22	KNOB CENTER KEY	YETE2	
650	2B	*	K29-7676-22	KNOB CENTER KEY	E3T2	
650	2B	*	K29-7676-22	KNOB CENTER KEY	MXI	
651	2B	*	K29-7678-04	KNOB VOLUME CONTROL	YETE2	
651	2B	*	K29-7679-04	KNOB VOLUME CONTROL	E3T2	
651	2B	*	K29-7679-04	KNOB VOLUME CONTROL	MXI	
652	2A	*	K29-7681-14	KNOB INPUT SELECTOR	YETE2	
652	2A	*	K29-7682-14	KNOB INPUT SELECTOR	E3T2	
652	2A	*	K29-7682-14	KNOB INPUT SELECTOR	MXI	
653	2A	*	K29-7684-03	KNOB MULTI CONTROL	YETE2	
653	2A	*	K29-7685-03	KNOB MULTI CONTROL	E3T2	
653	2A	*	K29-7685-03	KNOB MULTI CONTROL	MXI	
654	2B	*	K29-7687-03	KNOB POWER ON/STANDBY	YETE2	
654	2B	*	K29-7688-03	KNOB POWER ON/STANDBY	E3T2	
654	2B	*	K29-7688-03	KNOB POWER ON/STANDBY	MXI	
655	2A	*	K27-2384-04	KNOB (BUTTON) POWER ON/OFF	YETE2	
655	2A	*	K27-2385-04	KNOB (BUTTON) POWER ON/OFF	E3T2	
655	2A	*	K27-2385-04	KNOB (BUTTON) POWER ON/OFF	MXI	
△ 658	1B	*	L07-2923-05	POWER TRANSFORMER	YMI	
△ 658	1B	*	L07-2924-05	POWER TRANSFORMER	X	
△ 658	1B	*	L07-2925-05	POWER TRANSFORMER	ETE2	
△ 658	1B	*	L07-2925-05	POWER TRANSFORMER	E3T2	
661	1A	*	T90-0852-05	LOOP ANTENNA		
662	1A	*	T90-0877-05	LEAD WIRE ANTENNA		
665	2C	*	W02-2772-05	TUNER ASSY	YMXI	
665	2C	*	W02-2773-05	TUNER ASSY	ETE2	
665	2C	*	W02-2773-05	TUNER ASSY	E3T2	
665	2C	*	W02-2776-05	TUNER ASSY	YMXI	
665	2C	*	W02-2777-05	TUNER ASSY	ETE2	
665	2C	*	W02-2777-05	TUNER ASSY	E3T2	
KRF-V6050D/V6050D-S						
601	1A	*	A01-3795-01	METALLIC CABINET	YE	
601	1A	*	A01-3796-01	METALLIC CABINET	MXI	
602	1A	*	A09-1178-08	BATTERY COVER		
605	2B	*	A60-1929-01	PANEL	YE	
605	2B	*	A60-1930-01	PANEL	MXI	
606	1A	*	A70-1466-15	REMOTE CONTROL ASSY RC-R0615	YMXI	
606	1A	*	A70-1467-05	REMOTE CONTROL ASSY RC-R0616	E	
610	2A	*	B07-2550-02	ESCUTCHEON	YE	
610	2A	*	B07-2551-02	ESCUTCHEON	MXI	

L : Scandinavia K : USA P : Canada R : Mexico C : China I : Malaysia
Y : PX(Far East,Hawaii) T : England E : Europe G : Germany V : China(Shanghai)
Y : AAFES(Europe) X : Australia Q : Russia H : Korea M : Other Areas △ indicates safety critical components.

* New Parts
Parts without **Parts No.** are not supplied.
Les articles non mentionnés dans le **Parts No.** ne sont pas fournis.
Teile ohne **Parts No.** werden nicht geliefert.

Ref. No	Add-ress	New Parts	Parts No.	Description	Desti-nation	Re-marks
611	2A	*	B10-3655-02	FRONT GLASS	YMXI	
611	2A	*	B10-3656-02	FRONT GLASS	E	
613	2B		B12-0384-04	INDICATOR		
614	2B		B12-0385-04	INDICATOR		
615	2A		B43-0314-04	KENWOOD BADGE		
-			B46-0096-53	WARRANTY CARD	X	
-			B46-0310-03	WARRANTY CARD	E	
-			B46-0328-03	WARRANTY CARD	Y	
-			B58-0513-04	CAUTION CARD (PRESET220-240)	Y	
-			B58-0964-13	CAUTION CARD (UL)	Y	
-			B58-0965-13	CAUTION CARD (T,XtypePL)	X	
-			B58-0966-13	CAUTION CARD (ELMtypePL)	MIE	
-			B59-1104-00	SERVICE DIRECTORY	Y	
-		*	B60-4942-00	INSTRUCTION MANUAL (EN)	YMXI	
-		*	B60-4944-00	INSTRUCTION MANUAL (ES)	M	
-		*	B60-4945-00	INSTRUCTION MANUAL (TC)	MI	
-		*	B60-4948-00	INSTRUCTION MANUAL (FR/GE)	E	
-		*	B60-4949-00	INSTRUCTION MANUAL (NE/IT)	E	
-		*	B60-4950-00	INSTRUCTION MANUAL (ES)	E	
△ 619	1A		E03-0115-05	AC PLUG ADAPTER	M	
△ 620	1C		E30-2605-05	AC POWER CORD	Y	
△ 620	1C		E30-2717-05	AC POWER CORD	X	
△ 620	1C		E30-2942-05	AC POWER CORD	MIE	
621	2B,2C	*	E35-2774-15	FLAT CABLE 21P		
622	2B,2C	*	E35-2775-15	FLAT CABLE 7P		
623	1C,2C	*	E35-2776-05	FLAT CABLE 29P		
624	1C	*	E35-2777-05	FLAT CABLE 23P		
625	1C,2C	*	E35-2841-05	FLAT CABLE 19P		
-		*	H10-7743-02	POLYSTYRENE FOAMED FIXTURE		
-		*	H10-7744-02	POLYSTYRENE FOAMED FIXTURE		
-			H25-0232-04	PROTECTION BAG (235X350X0.03)		
-			H25-0391-04	PROTECTION BAG		
-		*	H50-3993-04	ITEM CARTON CASE	Y	
-		*	H50-3994-04	ITEM CARTON CASE	X	
-		*	H50-3995-04	ITEM CARTON CASE	MI	
-		*	H50-3996-04	ITEM CARTON CASE	E	
641	2B,2C		J02-1464-03	FOOT		
642	2B,2C		J19-3751-04	UNIT HOLDER		
643	1C		J19-6078-05	UNIT HOLDER		
△ 647	1C		J42-0083-05	POWER CORD BUSHING		
-			J61-0307-05	WIRE BAND		
650	2B		K29-7675-22	KNOB CENTER KEY	YE	
650	2B		K29-7676-22	KNOB CENTER KEY	MXI	
651	2B		K29-7678-04	KNOB VOLUME CONTROL	YE	
651	2B		K29-7679-04	KNOB VOLUME CONTROL	MXI	
652	2A		K29-7681-14	KNOB INPUT SELECTOR	YE	
652	2A		K29-7682-14	KNOB INPUT SELECTOR	MXI	
653	2A		K29-7684-03	KNOB MULTI CONTROL	YE	
653	2A		K29-7685-03	KNOB MULTI CONTROL	MXI	
654	2B		K29-7687-03	KNOB POWER ON/STANDBY	YE	
654	2B		K29-7688-03	KNOB POWER ON/STANDBY	MXI	
655	2A		K27-2384-04	KNOB (BUTTON) POWER ON/OFF	YE	
655	2A		K27-2385-04	KNOB (BUTTON) POWER ON/OFF	MXI	

L : Scandinavia K : USA P : Canada R : Mexico C : China I : Malaysia
Y : PX(Far East,Hawaii) T : England E : Europe G : Germany V : China(Shanghai)
Y : AAFES(Europe) X : Australia Q : Russia H : Korea M : Other Areas △ indicates safety critical components .

* New Parts
Parts without **Parts No.** are not supplied.
Les articles non mentionnés dans le **Parts No.** ne sont pas fournis.
Teile ohne **Parts No.** werden nicht geliefert.

Ref. No	Add-ress	New Parts	Parts No.	Description	Desti-nation	Re-marks
△ 658	1B	*	L07-2923-05	POWER TRANSFORMER	YMI	
△ 658	1B	*	L07-2924-05	POWER TRANSFORMER	X	
△ 658	1B	*	L07-2925-05	POWER TRANSFORMER	E	
661	1A		T90-0852-05	LOOP ANTENNA		
662	1A	*	T90-0877-05	LEAD WIRE ANTENNA		
665	2C	*	W02-2772-05	TUNER ASSY	YMXI	
665	2C	*	W02-2773-05	TUNER ASSY	E	
665	2C	*	W02-2776-05	TUNER ASSY	YMXI	
665	2C	*	W02-2777-05	TUNER ASSY	E	
KRF-V7050D/V7050D-S						
601	1A	*	A01-3793-01	METALLIC CABINET	ET	
601	1A	*	A01-3795-01	METALLIC CABINET	Y	
601	1A	*	A01-3796-01	METALLIC CABINET	MXI	
602	1A	*	A09-1178-08	BATTERY COVER		
604	2A	*	A22-1853-01	SUB PANEL	ET	
605	2A	*	A60-1744-12	PANEL	ET	
605	2A	*	A60-1929-01	PANEL	Y	
605	2A	*	A60-1930-01	PANEL	MXI	
606	1A	*	A70-1464-15	REMOTE CONTROL ASSY RC-R0613	YMXI	
606	1A	*	A70-1465-05	REMOTE CONTROL ASSY RC-R0614	ET	
610	2A	*	B07-2554-02	ESCUTCHEON	Y	
610	2A	*	B07-2555-02	ESCUTCHEON	MXI	
611	2A	*	B10-3650-12	FRONT GLASS	YXI	
611	2A	*	B10-3651-12	FRONT GLASS	M	
611	2A	*	B10-3652-12	FRONT GLASS	ET	
612	2A		B12-0341-04	INDICATOR	ET	
613	2B		B12-0383-04	INDICATOR		
614	2B		B12-0385-04	INDICATOR	YMXI	
615	2A		B43-0314-04	KENWOOD BADGE		
-			B46-0096-53	WARRANTY CARD		
-			B46-0310-03	WARRANTY CARD	ET	
-			B46-0328-03	WARRANTY CARD	Y	
-			B58-0513-04	CAUTION CARD (PRESET220-240)	Y	
-			B58-0945-03	CAUTION CARD	T	
-			B58-0964-13	CAUTION CARD (UL)	Y	
-			B58-0965-13	CAUTION CARD (T,XtypePL)	XT	
-			B58-0966-13	CAUTION CARD (ELMtypePL)	MIE	
-			B59-1104-00	SERVICE DIRECTORY	Y	
-		*	B60-4942-00	INSTRUCTION MANUAL (EN)	YMXI	
-		*	B60-4944-00	INSTRUCTION MANUAL (ES)	M	
-		*	B60-4945-00	INSTRUCTION MANUAL (TC)	MI	
-		*	B60-4947-00	INSTRUCTION MANUAL (EN)	T	
-		*	B60-4948-00	INSTRUCTION MANUAL (FR/GE)	E	
-		*	B60-4949-00	INSTRUCTION MANUAL (NE/IT)	E	
-		*	B60-4950-00	INSTRUCTION MANUAL (ES)	E	
△ 619	1A		E03-0115-05	AC PLUG ADAPTER	M	
△ 620	1C		E30-2605-05	AC POWER CORD	Y	
△ 620	1C		E30-2717-05	AC POWER CORD	X	
△ 620	1C		E30-2721-05	AC POWER CORD	T	
△ 620	1C		E30-2942-05	AC POWER CORD	MIE	
621	2B,2C	*	E35-2774-15	FLAT CABLE 21P		
622	2B,2C	*	E35-2775-15	FLAT CABLE 7P		
623	1C,2C	*	E35-2776-05	FLAT CABLE 29P		
624	1C	*	E35-2777-05	FLAT CABLE 23P		

L : Scandinavia K : USA P : Canada R : Mexico C : China I : Malaysia
Y : PX(Far East,Hawaii) T : England E : Europe G : Germany V : China(Shanghai)
Y : AAFES(Europe) X : Australia Q : Russia H : Korea M : Other Areas △ indicates safety critical components .

KRF-V5050D/V5550D/V6050D/V7050D/X9050D
PARTS LIST

* New Parts
 Parts without **Parts No.** are not supplied.
 Les articles non mentionnés dans le **Parts No.** ne sont pas fournis.
 Teile ohne **Parts No.** werden nicht geliefert.

5

Ref. No	Add-ress	New Parts	Parts No.	Description	Desti-nation	Re-marks
625	1C,2C	*	E35-2841-05	FLAT CABLE 19P		
-		*	H10-7743-02	POLYSTYRENE FOAMED FIXTURE		
-		*	H10-7744-02	POLYSTYRENE FOAMED FIXTURE		
-		*	H25-0232-04	PROTECTION BAG (235X350X0.03)		
-		*	H25-0391-04	PROTECTION BAG		
-		*	H50-3987-04	ITEM CARTON CASE	YT	
-		*	H50-3988-04	ITEM CARTON CASE	X	
-		*	H50-3989-04	ITEM CARTON CASE	MI	
-		*	H50-3991-04	ITEM CARTON CASE	E	
641	2B,2C		J02-1464-03	FOOT		
642	2B,2C		J19-3751-04	UNIT HOLDER		
643	1C		J19-6078-05	UNIT HOLDER		
647	1C		J42-0083-05	POWER CORD BUSHING		
-			J61-0307-05	WIRE BAND		
650	2B		K29-7675-22	KNOB CENTER KEY	YET	
650	2B		K29-7676-22	KNOB CENTER KEY	MXI	
651	2B		K29-7678-04	KNOB VOLUME CONTROL	YET	
651	2B		K29-7679-04	KNOB VOLUME CONTROL	MXI	
652	2A		K29-7681-14	KNOB MULTI/INPUT	YET	
652	2A		K29-7682-14	KNOB MULTI/INPUT	MXI	
654	2B		K29-7687-03	KNOB POWER ON/STANDBY	Y	
654	2B		K29-7688-03	KNOB POWER ON/STANDBY	MXI	
655	2A		K27-2384-04	KNOB (BUTTON) POWER ON/OFF	YET	
655	2A		K27-2385-04	KNOB (BUTTON) POWER ON/OFF	MXI	
658	1B	*	L07-2923-05	POWER TRANSFORMER	YMI	
658	1B	*	L07-2924-05	POWER TRANSFORMER	X	
658	1B	*	L07-2925-05	POWER TRANSFORMER	ET	
661	1A		T90-0852-05	LOOP ANTENNA		
662	1A	*	T90-0877-05	LEAD WIRE ANTENNA		
665	2C	*	W02-2772-05	TUNER ASSY	YMXI	
665	2C	*	W02-2773-05	TUNER ASSY	ET	
665	2C	*	W02-2776-05	TUNER ASSY	YMXI	
665	2C	*	W02-2777-05	TUNER ASSY	ET	
KRF-V5550D-S						
601	1A	*	A01-3796-01	METALLIC CABINET		
602	1A	*	A09-1178-08	BATTERY COVER		
605	2B	*	A60-1997-01	PANEL		
606	2B	*	A70-1507-05	REMOTE CONTROL ASSY RC-R0617		
610	2A	*	B07-2551-02	ESCUTCHEON		
611	2A	*	B10-3678-02	FRONT GLASS		
613	2B	*	B12-0384-04	INDICATOR		
614	2B	*	B12-0385-04	INDICATOR		
615	2A	*	B43-0314-04	KENWOOD BADGE		
-			B46-0328-03	WARRANTY CARD	Y	
-			B58-0513-04	CAUTION CARD (PRESET220-240)	Y	
-			B58-0964-13	CAUTION CARD (UL)	Y	
-			B58-0966-13	CAUTION CARD (ELMtypePK)	M	
-			B59-1104-00	SERVICE DIRECTORY	Y	
-		*	B60-4942-00	INSTRUCTION MANUAL (EN)		
-		*	B60-4944-00	INSTRUCTION MANUAL (ES)	M	
-		*	B60-4945-00	INSTRUCTION MANUAL (TC)	M	
619	1A		E03-0115-05	AC PLUG ADAPTER	M	

L : Scandinavia K : USA P : Canada R : Mexico C : China I : Malaysia
 Y : PX(Far East,Hawaii) T : England E : Europe G : Germany V : China(Shanghai)
 Y : AAFES(Europe) X : Australia Q : Russia H : Korea M : Other Areas Δ indicates safety critical components .

* New Parts
 Parts without **Parts No.** are not supplied.
 Les articles non mentionnés dans le **Parts No.** ne sont pas fournis.
 Teile ohne **Parts No.** werden nicht geliefert.

6

Ref. No	Add-ress	New Parts	Parts No.	Description	Desti-nation	Re-marks
620	1C		E30-2605-05	AC POWER CORD	Y	
620	1C		E30-2942-05	AC POWER CORD	M	
621	2B,2C	*	E35-2774-15	FLAT CABLE 21P		
623	1C,2C	*	E35-2776-05	FLAT CABLE 29P		
624	1C	*	E35-2777-05	FLAT CABLE 23P		
625	1C,2C	*	E35-2841-05	FLAT CABLE 19P		
-		*	H10-7743-02	POLYSTYRENE FOAMED FIXTURE		
-		*	H10-7744-02	POLYSTYRENE FOAMED FIXTURE		
-		*	H25-0232-04	PROTECTION BAG (235X350X0.03)		
-		*	H25-0391-04	PROTECTION BAG		
-		*	H50-4043-04	ITEM CARTON CASE	M	
-		*	H50-4148-04	ITEM CARTON CASE	Y	
641	2B,2C		J02-1464-03	FOOT		
642	2B,2C		J19-3751-04	UNIT HOLDER		
643	1C		J19-6078-05	UNIT HOLDER		
647	1C		J42-0083-05	POWER CORD BUSHING		
-			J61-0307-05	WIRE BAND		
650	2B		K29-7676-22	KNOB CENTER KEY		
651	2B		K29-7679-04	KNOB VOLUME CONTROL		
652	2A		K29-7682-14	KNOB INPUT SELECTOR		
653	2A		K29-7685-03	KNOB MULTI CONTROL		
654	2B		K29-7688-03	KNOB POWER ON/STANDBY		
655	2A		K27-2385-04	KNOB (BUTTON) POWER ON/OFF		
658	1B	*	L07-2926-05	POWER TRANSFORMER		
661	1A		T90-0852-05	LOOP ANTENNA		
662	1A	*	T90-0877-05	LEAD WIRE ANTENNA		
665	1C	*	W02-2772-05	TUNER ASSY		
665	1C	*	W02-2776-05	TUNER ASSY		
KRF-X9050D/X9050D-S						
601	1A	*	A01-3793-01	METALLIC CABINET	YET	
601	1A	*	A01-3794-01	METALLIC CABINET	MXI	
602	1A	*	A09-1215-08	BATTERY COVER		
604	2A	*	A22-1851-01	SUB PANEL	YET	
604	2A	*	A22-1852-01	SUB PANEL	MXI	
605	2B	*	A60-1937-02	PANEL	MXI	
605	2B	*	A60-1938-02	PANEL	YET	
606	1A	*	A70-1480-05	REMOTE CONTROL ASSY RC-R0714	YMXI	
606	1A	*	A70-1481-05	REMOTE CONTROL ASSY RC-R0715	ET	
611	2A	*	B10-3645-12	FRONT GLASS	YXI	
611	2A	*	B10-3646-12	FRONT GLASS	M	
611	2A	*	B10-3647-12	FRONT GLASS	ET	
612	2A	*	B12-0341-04	INDICATOR		
613	2B	*	B12-0383-04	INDICATOR		
615	2A		B43-0314-04	KENWOOD BADGE		
-			B46-0096-53	WARRANTY CARD	X	
-			B46-0310-03	WARRANTY CARD	ET	
-			B46-0328-03	WARRANTY CARD	Y	
-			B58-0513-04	CAUTION CARD (PRESET220-240)	Y	
-			B58-0945-03	CAUTION CARD	T	
-			B58-0964-13	CAUTION CARD (UL)	Y	
-			B58-0965-13	CAUTION CARD (T,XtypePL)	XT	

L : Scandinavia K : USA P : Canada R : Mexico C : China I : Malaysia
 Y : PX(Far East,Hawaii) T : England E : Europe G : Germany V : China(Shanghai)
 Y : AAFES(Europe) X : Australia Q : Russia H : Korea M : Other Areas Δ indicates safety critical components .

* New Parts
Parts without **Parts No.** are not supplied.
Les articles non mentionnés dans le **Parts No.** ne sont pas fournis.
Teile ohne **Parts No.** werden nicht geliefert.

⑦

Ref. No	Add-ress	New Parts	Parts No.	Description	Desti-nation	Re-marks
-			B58-0966-13	CAUTION CARD (ELMtypePL)	MIE	
-			B59-1104-00	SERVICE DIRECTORY	Y	
-		*	B60-4958-00	INSTRUCTION MANUAL (EN)	YMXIT	
-		*	B60-4959-00	INSTRUCTION MANUAL (FR/GE)	E	
-		*	B60-4960-00	INSTRUCTION MANUAL (NE/IT)	E	
-		*	B60-4961-00	INSTRUCTION MANUAL (ES)	ME	
-		*	B60-4962-00	INSTRUCTION MANUAL (TC)	MI	
△ 619	1A		E03-0115-05	AC PLUG ADAPTER	M	
△ 620	1C		E30-2605-05	AC POWER CORD	Y	
△ 620	1C		E30-2717-05	AC POWER CORD	X	
△ 620	1C		E30-2721-05	AC POWER CORD	T	
△ 620	1C		E30-2942-05	AC POWER CORD	MIE	
621	2B,2C	*	E35-2774-15	FLAT CABLE 21P		
622	2B,2C	*	E35-2775-15	FLAT CABLE 7P		
623	1C,2C	*	E35-2776-05	FLAT CABLE 29P		
624	1C	*	E35-2777-05	FLAT CABLE 23P		
625	1C,2C	*	E35-2841-05	FLAT CABLE 19P		
-		*	H10-7743-02	POLYSTYRENE FOAMED FIXTURE		
-		*	H10-7744-02	POLYSTYRENE FOAMED FIXTURE		
-			H25-0232-04	PROTECTION BAG (235X350X0.03)		
-			H25-0391-04	PROTECTION BAG		
-		*	H50-3981-04	ITEM CARTON CASE	YT	
-		*	H50-3982-04	ITEM CARTON CASE	X	
-		*	H50-3983-04	ITEM CARTON CASE	MI	
-		*	H50-3984-04	ITEM CARTON CASE	E	
641	2B,2C		J02-1464-03	FOOT		
642	2B,2C		J19-3751-04	UNIT HOLDER		
643	1C		J19-6078-05	UNIT HOLDER		
△ 647	1C		J42-0083-05	POWER CORD BUSHING		
-			J61-0307-05	WIRE BAND		
650	2B		K29-7675-22	KNOB CENTER KEY	YET	
650	2B		K29-7676-22	KNOB CENTER KEY	MXI	
651	2B		K29-7679-04	KNOB VOLUME CONTROL	MXI	
651	2B		K29-7877-04	KNOB VOLUME CONTROL	YET	
652	2A		K29-7682-14	KNOB MULT/INPUT	MXI	
652	2A		K29-7876-04	KNOB MULT/INPUT	YET	
655	2A		K27-2384-04	KNOB (BUTTON) POWER ON/OFF	YET	
655	2A		K27-2385-04	KNOB (BUTTON) POWER ON/OFF	MXI	
△ 658	1B	*	L07-2917-05	POWER TRANSFORMER	YMI	
△ 658	1B	*	L07-2918-05	POWER TRANSFORMER	X	
△ 658	1B	*	L07-2919-05	POWER TRANSFORMER	ET	
661	1A		T90-0852-05	LOOP ANTENNA		
662	1A	*	T90-0877-05	LEAD WIRE ANTENNA		
665	1C	*	W02-2776-05	TUNER ASSY	YMXI	
665	1C	*	W02-2777-05	TUNER ASSY	ET	
POWER SUPPLY UNIT(X00-3000-2X) YMIX type only						
CN1			E40-8386-05	PIN ASSY		
△ F3			F05-3121-05	FUSE (SEMKO) (250V T3.15AL)		
CN2 ,3			J13-0075-05	FUSE CLIP		
△ S1			S62-0001-05	SLIDE SWITCH		

L : Scandinavia K : USA P : Canada R : Mexico C : China I : Malaysia
Y : PX(Far East,Hawaii) T : England E : Europe G : Germany V : China(Shanghai)
Y : AAFES(Europe) X : Australia Q : Russia H : Korea M : Other Areas △ indicates safety critical components .

* New Parts
Parts without **Parts No.** are not supplied.
Les articles non mentionnés dans le **Parts No.** ne sont pas fournis.
Teile ohne **Parts No.** werden nicht geliefert.

②

Ref. No	Add-ress	New Parts	Parts No.	Description	Desti-nation	Re-marks
POWER AMPLIFIER UNIT(X07-329X/33XX-XX)						
C1 ,2			CC45FSL1H221J	CERAMIC 220PF	J	
C3 ,4			CE04KW1H100M	ELECTRO 10UF 50WV		5679
C5 ,6			CC45FSL1H221J	CERAMIC 220PF	J	5679
C7 ,8			GE04KW1A101M	ELECTRO 100UF 10WV		5679
C9 ,10			CC45FSL1H271J	CERAMIC 270PF	J	5679
C11 ,12			CQ93FMG1H123J	MYLAR 0.012UF	J	5679
C13 ,14			CK45FB1H332K	CERAMIC 3300PF	K	5679
C15 ,16			CC45FSL1H101J	CERAMIC 100PF	J	5679
C17 ,18			CE04KW1H4R7M	ELECTRO 4.7UF 50WV		5679
C19 -32			CC45FSL1H221J	CERAMIC 220PF	J	
C33 ,34			CC45FSL1H221J	CERAMIC 220PF	J	789
C35 ,36			CC45FSL1H221J	CERAMIC 220PF	J	79
C37 ,38			CE04PW1H2R2M	ELECTRO 2.2UF 50WV		
C39 ,40			CC45FSL1H101J	CERAMIC 100PF	J	
C41 ,42			GE04KW1H2R2M	ELECTRO 2.2UF 50WV		
C43 ,44			CC45FSL1H101J	CERAMIC 100PF	J	
C45 ,46		*	CE04PW1C220M	ELECTRO 22UF 16WV		
C47 ,48			CE04KW1H2R2M	ELECTRO 2.2UF 50WV		
C49 ,50			CK45FB1H471K	CERAMIC 470PF	K	
C51 ,52			CE04KW1A101M	ELECTRO 100UF 10WV		
C53 ,54			CK45FB1H471K	CERAMIC 470PF	K	
C55 ,56			CC45FCH1H180J	CERAMIC 18PF	J	
C57 -60			C91-1573-05	MP-C 0.10UF	J	
C61 ,62			CK45FB1H222K	CERAMIC 2200PF	K	
C101,102			GE04KW1H100M	ELECTRO 10UF 50WV		
C103,104			CE04KW1H2R2M	ELECTRO 2.2UF 50WV		
C105,106			CK45FB1H471K	CERAMIC 470PF	K	
C107,108			CE04KW1A101M	ELECTRO 100UF 10WV		
C109,110			CK45FB1H471K	CERAMIC 470PF	K	
C111,112			CC45FCH1H180J	CERAMIC 18PF	J	
C113-116			C91-1573-05	MP-C 0.10UF	J	6789
C117,118			CK45FB1H222K	CERAMIC 2200PF	K	5679
C119,120			CK45FB1H222K	CERAMIC 2200PF	K	
C131			GE04KW1H2R2M	ELECTRO 2.2UF 50WV		
C132			GE04KW1H2R2M	ELECTRO 2.2UF 50WV		
C133			CK45FB1H471K	CERAMIC 470PF	K	
C134			CK45FB1H471K	CERAMIC 470PF	K	
C135			CE04KW1A101M	ELECTRO 100UF 10WV		
C136			CE04KW1A101M	ELECTRO 100UF 10WV		
C137			CK45FB1H471K	CERAMIC 470PF	K	
C139			CC45FCH1H180J	CERAMIC 18PF	J	
C140			CC45FCH1H180J	CERAMIC 18PF	J	
C141			C91-1573-05	MP-C 0.10UF	J	
C142			C91-1573-05	MP-C 0.10UF	J	
C143			C91-1573-05	MP-C 0.10UF	J	
C144			C91-1573-05	MP-C 0.10UF	J	
C145			CK45FB1H222K	CERAMIC 2200PF	K	
C146			CK45FB1H222K	CERAMIC 2200PF	K	
C147			CC45FSL1H221J	CERAMIC 220PF	J	8
C151-155			CC45FSL1H101J	CERAMIC 100PF	J	567
C201,202		*	C90-3945-05	ELECTRO 10000UF 80WV		9
C201,202		*	C90-3982-05	ELECTRO 4700UF 75WV	YMXI	567
C201,202		*	C90-3984-05	ELECTRO 4700UF 75WV		8

L : Scandinavia K : USA P : Canada R : Mexico C : China I : Malaysia
Y : PX(Far East,Hawaii) T : England E : Europe G : Germany V : China(Shanghai)
Y : AAFES(Europe) X : Australia Q : Russia H : Korea M : Other Areas △ indicates safety critical components .

PARTS LIST

KRF-V5050D/V5550D/V6050D/V7050D/V9050D

* New Parts
Parts without **Parts No.** are not supplied.
Les articles non mentionnés dans le **Parts No.** ne sont pas fournis.
Teile ohne **Parts No.** werden nicht geliefert.

Ref. No	Add-ress	New Parts	Parts No.	Description	Desti-nation	Re-marks
R132			RD14BB2C222J	RD 2.2K J 1/6W		5678
R134			RD14BB2C104J	RD 100K J 1/6W		8
R136			RD14BB2C333J	RD 33K J 1/6W		8
R138			RD14BB2C102J	RD 1.0K J 1/6W		8
R139			RS14KB3DR22J	FL-PROOF RS 0.22 J 2W		
R140			RS14KB3DR22J	FL-PROOF RS 0.22 J 2W		8
R141			RS14KB3DR22J	FL-PROOF RS 0.22 J 2W		8
R142			RS14KB3DR22J	FL-PROOF RS 0.22 J 2W		8
R144			RD14BB2C102J	RD 1.0K J 1/6W		8
R146			RD14BB2C333J	RD 33K J 1/6W		8
R147			RD14BB2C112J	RD 1.1K J 1/6W	YMXI	567
R147			RD14BB2C122J	RD 1.2K J 1/6W		89
R147			RD14BB2C122J	RD 1.2K J 1/6W	ET	567
R147			RD14BB2C122J	RD 1.2K J 1/6W	E2E3T2	5
R148			RD14BB2C122J	RD 1.2K J 1/6W		8
R149			RD14NB2E4R7J	RD 4.7 J 1/4W		
R150			RD14NB2E4R7J	RD 4.7 J 1/4W		8
R151			RS14KB3D4R7J	FL-PROOF RS 4.7 J 2W		
R152			RS14KB3D4R7J	FL-PROOF RS 4.7 J 2W		8
R153			RD14BB2C224J	RD 220K J 1/6W		567
R154	Δ		RD14BB2C331J	RD 330 J 1/6W		567
R207			RD14NB2E101J	RD 100 J 1/4W		
R208			RD14NB2E822J	RD 8.2K J 1/4W		
R216			RD14BB2C333J	RD 33K J 1/6W		8
R222			RD14BB2C513J	RD 51K J 1/6W		8
R223-226			RS14KB3A472J	FL-PROOF RS 4.7K J 1W		
R238,239			RD14NB2E103J	RD 10K J 1/4W		
R242,243			RD14NB2E101J	RD 100 J 1/4W		
R254	Δ		RS14KB3D181J	FL-PROOF RS 180 J 2W		9
R262			RD14NB2E1R0J	RD 1 J 1/4W		
R263			RD14NB2E151J	RD 150 J 1/4W	ET	
R263			RD14NB2E151J	RD 150 J 1/4W	E2E3T2	
R263			RD14NB2E181J	RD 180 J 1/4W	X	
R263			RD14NB2E2R2J	RD 2.2 J 1/4W	YMI	
R301,302	Δ		RD14NB2E1R0J	RD 1 J 1/4W		
R315,316			RD14BB2C103J	RD 10K J 1/6W		5678
R315,316			RD14BB2C912J	RD 9.1K J 1/6W		9
R318			RD14BB2C303J	RD 30K J 1/6W		8
R319			RD14BB2C103J	RD 10K J 1/6W		5678
R319			RD14BB2C912J	RD 9.1K J 1/6W		9
R320			RD14BB2C103J	RD 10K J 1/6W		8
R321-323			RS14KB3A151J	FL-PROOF RS 150 J 1W		
R330			RD14BB2C102J	RD 1.0K J 1/6W		5678
R335			RD14NB2E821J	RD 820 J 1/4W		
R336			RD14BB2C102J	RD 1.0K J 1/6W		5678
R356			RD14BB2C471J	RD 470 J 1/6W		8
R998,999			RD14NB2E1R0J	RD 1 J 1/4W		
K1 ,2			S76-0042-05	MAGNETIC RELAY	YMXI	
K1 ,2			S76-0097-05	MAGNETIC RELAY		
K1 ,2		*	S76-0112-05	MAGNETIC RELAY	ET	
K1 ,2		*	S76-0112-05	MAGNETIC RELAY	E2E3T2	
K3			S76-0042-05	MAGNETIC RELAY	YMXI	5679
K3		*	S76-0097-05	MAGNETIC RELAY		5679
K3		*	S76-0112-05	MAGNETIC RELAY	ET	5679

L : Scandinavia K : USA P : Canada R : Mexico C : China I : Malaysia
Y : PX(Far East,Hawaii) T : England E : Europe G : Germany V : China(Shanghai)
Y : AAFES(Europe) X : Australia Q : Russia H : Korea M : Other Areas Δ indicates safety critical components .

* New Parts
Parts without **Parts No.** are not supplied.
Les articles non mentionnés dans le **Parts No.** ne sont pas fournis.
Teile ohne **Parts No.** werden nicht geliefert.

Ref. No	Add-ress	New Parts	Parts No.	Description	Desti-nation	Re-marks
K3		*	S76-0112-05	MAGNETIC RELAY	E2E3T2	5679
K4			S76-0042-05	MAGNETIC RELAY	YMXI	6789
K4			S76-0097-05	MAGNETIC RELAY		6789
K4		*	S76-0112-05	MAGNETIC RELAY	ET	679
K5			S76-0107-05	MAGNETIC RELAY		
D1	Δ		D5SBA20F03	DIODE		
D1	Δ	*	TS6P03G-B	DIODE		
D2	Δ	*	TS10P03G-B	DIODE		
D3	Δ		D2SBA20F03	DIODE		
D4			MTZJ16(B)	ZENER DIODE		
D4			RD16ES(B)	ZENER DIODE		
D5 -9			MTZJ15(B)	ZENER DIODE		
D5 -9			RD15ES(B)	ZENER DIODE		
D10 -14			HSS104A	DIODE		
D10 -14			1SS133	DIODE		
D15			HSS104A	DIODE		8
D15			1SS133	DIODE		8
D16 ,17			HSS104A	DIODE		
D16 ,17			1SS133	DIODE		
D18			MTZJ6.8(B)	ZENER DIODE		8
D18			MTZJ6.8(B)	ZENER DIODE	ET	567
D18			MTZJ8.2(B)	ZENER DIODE	E2E3T2	5
D18			MTZJ8.2(B)	ZENER DIODE	YMXI	567
D18			RD6.8ES(B)	ZENER DIODE		8
D18			RD6.8ES(B)	ZENER DIODE		567
D18			RD6.8ES(B)	ZENER DIODE	E2E3T2	5
D18			RD8.2ES(B)	ZENER DIODE		9
D18			RD8.2ES(B)	ZENER DIODE	YMXI	567
D19			MTZJ15(B)	ZENER DIODE		8
D19			MTZJ15(B)	ZENER DIODE	YMXI	9
D19			MTZJ16(B)	ZENER DIODE		567
D19			MTZJ16(B)	ZENER DIODE	ET	9
D19			MTZJ16(B)	ZENER DIODE		8
D19			RD15ES(B)	ZENER DIODE	YMXI	9
D19			RD15ES(B)	ZENER DIODE		9
D19			RD16ES(B)	ZENER DIODE		567
D19			RD16ES(B)	ZENER DIODE	ET	9
D20			MTZJ13(B)	ZENER DIODE		8
D20			MTZJ15(B)	ZENER DIODE	ET	567
D20			MTZJ15(B)	ZENER DIODE	E2E3T2	5
D20			MTZJ16(B)	ZENER DIODE		9
D20			MTZJ16(B)	ZENER DIODE	ET	567
D20			MTZJ16(B)	ZENER DIODE	MI	567
D20			MTZJ18(B)	ZENER DIODE	YX	567
D20			MTZJ20(B)	ZENER DIODE	YMXI	9
D20			RD13ES(B)	ZENER DIODE		8
D20			RD15ES(B)	ZENER DIODE		567
D20			RD15ES(B)	ZENER DIODE	E2E3T2	5
D20			RD16ES(B)	ZENER DIODE		9
D20			RD16ES(B)	ZENER DIODE	ET	567
D20			RD16ES(B)	ZENER DIODE	MI	567
D20			RD18ES(B)	ZENER DIODE	YX	567
D20			RD20ES(B)	ZENER DIODE	YMXI	9
D21			HSS104A	DIODE		
D21			1SS133	DIODE		
D22 ,23			MTZJ3.9(B)	ZENER DIODE		
D22 ,23			RD3.9ES(B)	ZENER DIODE		

L : Scandinavia K : USA P : Canada R : Mexico C : China I : Malaysia
Y : PX(Far East,Hawaii) T : England E : Europe G : Germany V : China(Shanghai)
Y : AAFES(Europe) X : Australia Q : Russia H : Korea M : Other Areas Δ indicates safety critical components .

KRF-V5050D/V5550D/V6050D/V7050D/X9050D
PARTS LIST

* New Parts
Parts without **Parts No.** are not supplied.
Les articles non mentionnés dans le **Parts No.** ne sont pas fournis.
Teile ohne **Parts No.** werden nicht geliefert.

13

Ref. No	Add-ress	New Parts	Parts No.	Description	Desti-nation	Re-marks
D24 -26			HSS104A	DIODE		
D24 -26			1SS133	DIODE		
D27			HSS104A	DIODE		5679
D27			1SS133	DIODE		5679
D28			HSS104A	DIODE		6789
D28			1SS133	DIODE		6789
D29 ,30			HSS104A	DIODE	YMI	
D29 ,30			1SS133	DIODE	YMI	
D31			MTZJ3.9(B)	ZENER DIODE		
D31			RD3.9ES(B)	ZENER DIODE		
Δ D32 -34			HSS104A	DIODE		
Δ D32 -34			1SS133	DIODE		
Δ D35			S1ZB20(4101)	DIODE		
Δ D36			RB721Q	DIODE		
Δ D37			HSS104A	DIODE		
D37			1SS133	DIODE		
Δ IC1			STK412-020A	HYBRID IC		567
Δ IC1		*	STK412-040N	HYBRID IC		9
Δ IC1		*	STK412-040T	HYBRID IC		9
Δ IC2			STK413-020A	HYBRID IC		567
Δ IC2		*	STK413-040T	HYBRID IC		9
Δ IC3 ,4			STK413-010A	HYBRID IC		8
Δ IC5			KIA7812API	ANALOGUE IC		
Δ IC6			KIA7912PI	ANALOGUE IC		
Δ IC7			NJM4580L-D	ANALOGUE IC		5679
IC8			NJU7313AL	ANALOGUE IC		
IC9 ,10			NJM4565D	ANALOGUE IC		
IC11			NJU7313AL	ANALOGUE IC		
Δ IC12			BA05T	ANALOGUE IC		
Q1 -5			2SC2878(B)	TRANSISTOR		
Q6			2SC2878(B)	TRANSISTOR		5678
Q201			2SB1640	TRANSISTOR		
Q202			2SC1845(F,E)	TRANSISTOR		
Q203			2SA1535A	TRANSISTOR		
Q205			2SC1845(F,E)	TRANSISTOR		
Q206			2SA992(F,E)	TRANSISTOR		
Q207			2SC3944A	TRANSISTOR		
Q208			2SB1640	TRANSISTOR		
Q209,210			2SA992(F,E)	TRANSISTOR		
Q211-214			2SC1845(F,E)	TRANSISTOR		
Q215			2SC1740S(Q,R)	TRANSISTOR		
Q215			2SC2785(F,E)	TRANSISTOR		
Q301-305			2SC1845(F,E)	TRANSISTOR		
Q306			2SC1845(F,E)	TRANSISTOR		
Q307,308			UN4219	DIGITAL TRANSISTOR		
Q309			UN4219	DIGITAL TRANSISTOR		5679
Q310			UN4219	DIGITAL TRANSISTOR		6789
Q311			2SA992(F,E)	TRANSISTOR		
SURROUND UNIT (X08-3060-1X)						
C1 ,2			CE04LW1H100M	ELECTRO	10UF	50WV
C3			CK73GB1H103K	CHIP C	0.010UF	K
C4			CC73GCH1H101J	CHIP C	100PF	J
C5 ,6			CK73GB1H222K	CHIP C	2200PF	K
C7 ,8			CK73FB1E104K	CHIP C	0.10UF	K

L : Scandinavia K : USA P : Canada R : Mexico C : China I : Malaysia
Y : PX(Far East,Hawaii) T : England E : Europe G : Germany V : China(Shanghai)
Y : AAFES(Europe) X : Australia Q : Russia H : Korea M : Other Areas Δ indicates safety critical components .

* New Parts
Parts without **Parts No.** are not supplied.
Les articles non mentionnés dans le **Parts No.** ne sont pas fournis.
Teile ohne **Parts No.** werden nicht geliefert.

14

Ref. No	Add-ress	New Parts	Parts No.	Description	Desti-nation	Re-marks
C9 ,10			CE04LW1H4R7M	ELECTRO	4.7UF	50WV
C11 ,14			CC73GCH1H101J	CHIP C	100PF	J
C21			CK73FB1E104K	CHIP C	0.10UF	K
C22			CE04LW1H100M	ELECTRO	10UF	50WV
C23			CK73GB1H102K	CHIP C	1000PF	K
C24 ,25			CK73FB1E104K	CHIP C	0.10UF	K
C26			CE04LW1H100M	ELECTRO	10UF	50WV
C27			CE04LW1H4R7M	ELECTRO	4.7UF	50WV
C29			CK73GB1H103K	CHIP C	0.010UF	K
C31			CC73GCH1H220J	CHIP C	22PF	J
C32			CK73GB1H472K	CHIP C	4700PF	K
C33			CC73GCH1H220J	CHIP C	22PF	J
C34			CK73GB1H472K	CHIP C	4700PF	K
C35			CK73FF1C105Z	CHIP C	1.0UF	Z
C36			CK73FF1C105Z	CHIP C	1.0UF	Z
C37			CK73FF1C105Z	CHIP C	1.0UF	Z
C41			CC73GCH1H220J	CHIP C	22PF	J
C42			CC73GCH1H270J	CHIP C	27PF	J
C43 ,44			CK73GB1H102K	CHIP C	1000PF	K
C45			CK73GB1H103K	CHIP C	0.010UF	K
C46			CC73GCH1H220J	CHIP C	22PF	J
C54 ,55			CC73GCH1H220J	CHIP C	22PF	J
C56			CK73GB1H102K	CHIP C	1000PF	K
C57			CK73FB1E104K	CHIP C	0.10UF	K
C58 ,59			CK73GB1H103K	CHIP C	0.010UF	K
C103,104			CE04PW1H100M	ELECTRO	10UF	50WV
C105,106			CK73GB1H182K	CHIP C	1800PF	K
C107,108			CK73GB1H222K	CHIP C	2200PF	K
C109			CK73GB1H472K	CHIP C	4700PF	K
C110			CC73GCH1H101J	CHIP C	100PF	J
C111,112			CC73GCH1H101J	CHIP C	100PF	J
C121,122			CC73GCH1H220J	CHIP C	22PF	J
C125			CK73GB1H103K	CHIP C	0.010UF	K
C126			CC73GCH1H101J	CHIP C	100PF	J
C141			CC73GCH1H101J	CHIP C	100PF	J
C151,152			CE04LW1H4R7M	ELECTRO	4.7UF	50WV
C151,152		*	CE04PW2A4R7M	ELECTRO	4.7UF	100WV
C153,154			CC73GCH1H101J	CHIP C	100PF	J
C155-157			CE04LW1H4R7M	ELECTRO	4.7UF	50WV
C155-157		*	CE04PW2A4R7M	ELECTRO	4.7UF	100WV
C158-160			CE04PW1H4R7M	ELECTRO	4.7UF	50WV
C161,162			CK73GB1H223K	CHIP C	0.022UF	K
C163,164			CK73GB1C333K	CHIP C	0.033UF	K
C165,166			CK73FB1C474K	CHIP C	0.47UF	K
C167,168			CE04LW1H4R7M	ELECTRO	4.7UF	50WV
C169,170			CK73GB1H222K	CHIP C	2200PF	K
C177-181			CE04KW1H4R7M	ELECTRO	4.7UF	50WV
C182			CE04PW1H4R7M	ELECTRO	4.7UF	50WV
C183			CK73FF1C105Z	CHIP C	1.0UF	Z
C184			CC73GCH1H221J	CHIP C	220PF	J
C185,186			CK73FB1E104K	CHIP C	0.10UF	K
C189,190			CE04PW1H100M	ELECTRO	10UF	50WV
C203,204			CE04PW1H100M	ELECTRO	10UF	50WV
C205,206			CK73GB1H222K	CHIP C	2200PF	K
C207,208			CK73GB1H821K	CHIP C	820PF	K

L : Scandinavia K : USA P : Canada R : Mexico C : China I : Malaysia
Y : PX(Far East,Hawaii) T : England E : Europe G : Germany V : China(Shanghai)
Y : AAFES(Europe) X : Australia Q : Russia H : Korea M : Other Areas Δ indicates safety critical components .

PARTS LIST

KRF-V5050D/V5550D/V6050D/V7050D/X9050D

* New Parts
 Parts without **Parts No.** are not supplied.
 Les articles non mentionnés dans le **Parts No.** ne sont pas fournis.
 Teile ohne **Parts No.** werden nicht geliefert.

Ref. No	Add-ress	New Parts	Parts No.	Description	Desti-nation	Re-marks
C209			CK73GB1H472K	CHIP C	4700PF	K
C210			CC73GCH1H101J	CHIP C	100PF	J
C211,212			CC73GCH1H101J	CHIP C	100PF	J
C215,216			CK73GB1H102K	CHIP C	1000PF	K
C251-256			CC73GCH1H221J	CHIP C	220PF	J
C303,304			CE04PW1H100M	ELECTRO	10UF	50WV
C305			CK73GB1H182K	CHIP C	1800PF	K
C306			CK73GB1H822K	CHIP C	8200PF	K
C307			CK73GB1H222K	CHIP C	2200PF	K
C308			CK73GB1H822K	CHIP C	8200PF	K
C309			CK73GB1H103K	CHIP C	0.010UF	K
C310			CC73GCH1H101J	CHIP C	100PF	J
C311			CC73GCH1H101J	CHIP C	100PF	J
C401,402			CK73GB1H103K	CHIP C	0.010UF	K
C451			CK73FB1E104K	CHIP C	0.10UF	K
C452			CE04KW1C472M	ELECTRO	4700UF	16WV
C453,454			CK73FB1E104K	CHIP C	0.10UF	K
C455			CE04LW1E470M	ELECTRO	47UF	25WV
C456,457			CK73FB1E104K	CHIP C	0.10UF	K
C458			CE04LW1E470M	ELECTRO	47UF	25WV
C459			CE04PW1H100M	ELECTRO	10UF	50WV
C460			CK73FB1E104K	CHIP C	0.10UF	K
C461			CE04PW1E470M	ELECTRO	47UF	25WV
C462			CE04PW1H100M	ELECTRO	10UF	50WV
C463			CK73FB1E104K	CHIP C	0.10UF	K
C464			CE04PW1E470M	ELECTRO	47UF	25WV
C465			CK73GB1H103K	CHIP C	0.010UF	K
C468,469			CC73GCH1H101J	CHIP C	100PF	J
C501-504			CK73FB1E104K	CHIP C	0.10UF	K
C505			CK73GB1H102K	CHIP C	1000PF	K
C506			CC73GCH1H471J	CHIP C	470PF	J
C507			CK73GB1H103K	CHIP C	0.010UF	K
C508			CE04LW1H2R2M	ELECTRO	2.2UF	50WV
C509			CE04PW1E470M	ELECTRO	47UF	25WV
C510			CK73GB1H103K	CHIP C	0.010UF	K
C601-604			CK73FB1E104K	CHIP C	0.10UF	K
C605			CK73GB1H102K	CHIP C	1000PF	K
C606			CC73GCH1H471J	CHIP C	470PF	J
C607			CK73GB1H103K	CHIP C	0.010UF	K
C608			CE04LW1H2R2M	ELECTRO	2.2UF	50WV
C609			CE04PW1E470M	ELECTRO	47UF	25WV
C610			CK73GB1H103K	CHIP C	0.010UF	K
C651			CE04PW1H010M	ELECTRO	1UF	50WV
C652			CE04PW1C101M	ELECTRO	100UF	16WV
C653			CE04PW1H100M	ELECTRO	10UF	50WV
C654			CE04LW1C101M	ELECTRO	100UF	16WV
C655			CE04EW1C471M	ELECTRO	470UF	16WV
C701,702			CK73GB1H471K	CHIP C	470PF	K
C703,704			CE04KW1E470M	ELECTRO	47UF	25WV
C705,706			CC73GCH1H220J	CHIP C	22PF	J
C707,708			CE04KW1H100M	ELECTRO	10UF	50WV
C709,710			CC73GCH1H330J	CHIP C	33PF	J
C711,712			CC73GCH1H470J	CHIP C	47PF	J
C713			CC73GCH1H101J	CHIP C	100PF	J
C714			CK73GB1H103K	CHIP C	0.010UF	K

L : Scandinavia K : USA P : Canada R : Mexico C : China I : Malaysia
 Y : PX(Far East,Hawaii) T : England E : Europe G : Germany V : China(Shanghai)
 Y : AAFES(Europe) X : Australia Q : Russia H : Korea M : Other Areas Δ indicates safety critical components .

* New Parts
 Parts without **Parts No.** are not supplied.
 Les articles non mentionnés dans le **Parts No.** ne sont pas fournis.
 Teile ohne **Parts No.** werden nicht geliefert.

Ref. No	Add-ress	New Parts	Parts No.	Description	Desti-nation	Re-marks
C715,716			CE04LW1E470M	ELECTRO	47UF	25WV
C801,802			CK73GB1H471K	CHIP C	470PF	K
C803,804			CE04KW1E470M	ELECTRO	47UF	25WV
C805,806			CC73GCH1H220J	CHIP C	22PF	J
C807,808			CE04LW1E470M	ELECTRO	47UF	25WV
C809,810			CC73GCH1H330J	CHIP C	33PF	J
C811,812			CC73GCH1H470J	CHIP C	47PF	J
C813			CC73GCH1H101J	CHIP C	100PF	J
C814			CK73GB1H103K	CHIP C	0.010UF	K
C901,902			CK73GB1H471K	CHIP C	470PF	K
C903			CE04KW1E470M	ELECTRO	47UF	25WV
C904			CE04KW1E221M	ELECTRO	220UF	25WV
C905,906			CC73GCH1H220J	CHIP C	22PF	J
C907,908			CE04KW1H100M	ELECTRO	10UF	50WV
C909			CC73GCH1H330J	CHIP C	33PF	J
C910			CK73GB1H222K	CHIP C	2200PF	K
C911			CC73GCH1H470J	CHIP C	47PF	J
C913			CC73GCH1H101J	CHIP C	100PF	J
C914			CK73GB1H103K	CHIP C	0.010UF	K
C915,916			CE04LW1E470M	ELECTRO	47UF	25WV
CN1			E40-8485-05	FLAT CABLE CONNECTOR		
CN2			E40-9842-05	PIN ASSY		
CN3			E40-8488-05	FLAT CABLE CONNECTOR		
CN5			E40-3246-05	PIN ASSY		
J1			E63-1080-05	PIN JACK		
J2			E63-1139-05	PIN JACK		
E2			F10-1197-04	SHIELDING PLATE		
E1			J11-0808-05	WIRE CLAMPER		
L41			L92-0510-05	CHIP FERRITE		
X1			L77-2296-05	CRYSTAL RESONATOR(12.288MHZ)		
CP51,52			R90-0714-05	MULTI-COMP	10K X4	
CP61,62			R90-0714-05	MULTI-COMP	10K X4	
CP90,91			R90-0728-05	MULTI-COMP	180 X4	
CP92			R90-0728-05	MULTI-COMP	180 X4	
CP93,96			R90-0728-05	MULTI-COMP	180 X4	
R1 ,2			RK73GB1J562J	CHIP R	5.6K	J 1/16W
R3 ,4			RK73GB1J101J	CHIP R	100	J 1/16W
R5 ,6			RK73GB1J471J	CHIP R	470	J 1/16W
R7 -10			RK73GB1J472J	CHIP R	4.7K	J 1/16W
R11 ,12			RK73GB1J471J	CHIP R	470	J 1/16W
R20			RD14NB2E4R7J	RD	4.7	J 1/4W
R21			RK73GB1J221J	CHIP R	220	J 1/16W
R31 ,32			RK73GB1J820J	CHIP R	82	J 1/16W
R33			RK73GB1J471J	CHIP R	470	J 1/16W
R34			RD14NB2E4R7J	RD	4.7	J 1/4W
R35			RK73GB1J471J	CHIP R	470	J 1/16W
R36			RD14NB2E4R7J	RD	4.7	J 1/4W
R37			RK73GB1J471J	CHIP R	470	J 1/16W
R38			RD14NB2E4R7J	RD	4.7	J 1/4W
R41 ,42			RK73GB1J105J	CHIP R	1.0M	J 1/16W
R43 -45			RK73GB1J221J	CHIP R	220	J 1/16W
R54			RK73GB1J183J	CHIP R	18K	J 1/16W

L : Scandinavia K : USA P : Canada R : Mexico C : China I : Malaysia
 Y : PX(Far East,Hawaii) T : England E : Europe G : Germany V : China(Shanghai)
 Y : AAFES(Europe) X : Australia Q : Russia H : Korea M : Other Areas Δ indicates safety critical components .

KRF-V5050D/V5550D/V6050D/V7050D/X9050D
PARTS LIST

* New Parts
 Parts without **Parts No.** are not supplied.
 Les articles non mentionnés dans le **Parts No.** ne sont pas fournis.
 Teile ohne **Parts No.** werden nicht geliefert.

17

Ref. No	Add-ress	New Parts	Parts No.	Description	Desti-nation	Re-marks
R55 -57			RK73GB1J220J	CHIP R 22 J 1/16W		
R58			RK73GB1J221J	CHIP R 220 J 1/16W		
R59			RK73GB1J220J	CHIP R 22 J 1/16W		
R66			RK73GB1J104J	CHIP R 100K J 1/16W		
R67			RK73GB1J103J	CHIP R 10K J 1/16W		
R68			RK73GB1J221J	CHIP R 220 J 1/16W		
R101,102			RK73GB1J222J	CHIP R 2.2K J 1/16W		
R103,104			RK73GB1J104J	CHIP R 100K J 1/16W		
R107,108			RK73GB1J222J	CHIP R 2.2K J 1/16W		
R109,110			RK73GB1J103J	CHIP R 10K J 1/16W		
R111,112			RK73GB1J472J	CHIP R 4.7K J 1/16W		
R113,114			RK73GB1J221J	CHIP R 220 J 1/16W		
R121-124			RK73GB1J103J	CHIP R 10K J 1/16W		
R125,126			RK73GB1J101J	CHIP R 100 J 1/16W		
R127,128			RK73GB1J242J	CHIP R 2.4K J 1/16W		
R141-146			RK73GB1J1R0J	CHIP R 1 J 1/16W	8	
R151-156			RK73GB1J100J	CHIP R 10 J 1/16W		
R157,158			RK73GB1J221J	CHIP R 220 J 1/16W		
R159-164			RK73GB1J101J	CHIP R 100 J 1/16W		
R165			RK73GB1J392J	CHIP R 3.9K J 1/16W		
R166			RK73GB1J272J	CHIP R 2.7K J 1/16W		
R168,169			RK73FB2A1R0J	CHIP R 1 J 1/10W		
R170,171			RK73GB1J471J	CHIP R 470 J 1/16W		
R172,173			RK73GB1J101J	CHIP R 100 J 1/16W		
R201,202			RK73GB1J332J	CHIP R 3.3K J 1/16W		
R203,204			RK73GB1J104J	CHIP R 100K J 1/16W		
R207,208			RK73GB1J222J	CHIP R 2.2K J 1/16W		
R209,210			RK73GB1J272J	CHIP R 2.7K J 1/16W		
R211,212			RK73GB1J562J	CHIP R 5.6K J 1/16W		
R213,214			RK73GB1J221J	CHIP R 220 J 1/16W		
R215,216			RK73GB1J472J	CHIP R 4.7K J 1/16W		
R217,218			RK73GB1J562J	CHIP R 5.6K J 1/16W		
R220			RK73GB1J103J	CHIP R 10K J 1/16W		
R251,252			RK73GB1J153J	CHIP R 15K J 1/16W	5679	
R253,254			RK73GB1J223J	CHIP R 22K J 1/16W	5679	
R255,256			RK73GB1J103J	CHIP R 10K J 1/16W	5679	
R257,258			RK73GB1J223J	CHIP R 22K J 1/16W	5679	
R259,260			RK73GB1J103J	CHIP R 10K J 1/16W	5679	
R261,262			RK73GB1J223J	CHIP R 22K J 1/16W	5679	
R263,264			RK73GB1J101J	CHIP R 100 J 1/16W	5679	
R301			RK73GB1J222J	CHIP R 2.2K J 1/16W		
R302			RK73GB1J153J	CHIP R 15K J 1/16W		
R303,304			RK73GB1J104J	CHIP R 100K J 1/16W		
R307			RK73GB1J222J	CHIP R 2.2K J 1/16W		
R308			RK73GB1J183J	CHIP R 18K J 1/16W		
R309,310			RK73GB1J103J	CHIP R 10K J 1/16W		
R311			RK73GB1J472J	CHIP R 4.7K J 1/16W		
R312			RK73GB1J562J	CHIP R 5.6K J 1/16W		
R313			RK73GB1J102J	CHIP R 1.0K J 1/16W		
R314			RK73GB1J221J	CHIP R 220 J 1/16W		
R401-405			RK73GB1J471J	CHIP R 470 J 1/16W		
R407,408			RK73GB1J471J	CHIP R 470 J 1/16W		
R411			RK73GB1J471J	CHIP R 470 J 1/16W		
R449			RS14KB3D180J	FL-PROOF RS 18 J 2W	9	
R451			R92-1945-05	METAL GLAZE 1 J 1/4W		

L : Scandinavia K : USA P : Canada R : Mexico C : China I : Malaysia
 Y : PX(Far East,Hawaii) T : England E : Europe G : Germany V : China(Shanghai)
 Y : AAFES(Europe) X : Australia Q : Russia H : Korea M : Other Areas Δ indicates safety critical components .

PARTS LIST

18

* New Parts
 Parts without **Parts No.** are not supplied.
 Les articles non mentionnés dans le **Parts No.** ne sont pas fournis.
 Teile ohne **Parts No.** werden nicht geliefert.

Ref. No	Add-ress	New Parts	Parts No.	Description	Desti-nation	Re-marks
R452			RD14NB2E1R0J	RD 1 J 1/4W		
R453			RD14NB2E4R7J	RD 4.7 J 1/4W		
R454			RS14KB3D180J	FL-PROOF RS 18 J 2W		
R459			R92-1993-05	METAL GLAZE 560 J 1/4W		
R460			RK73GB1J223J	CHIP R 22K J 1/16W		
R461			R92-1993-05	METAL GLAZE 560 J 1/4W		9
R462			RK73GB1J223J	CHIP R 22K J 1/16W		9
R491,492			RK73GB1J221J	CHIP R 220 J 1/16W		
R493			RK73GB1J473J	CHIP R 47K J 1/16W		
R494			RK73GB1J472J	CHIP R 4.7K J 1/16W		
R495			RK73GB1J102J	CHIP R 1.0K J 1/16W		
R496			RK73GB1J152J	CHIP R 1.5K J 1/16W		
R501			RK73GB1J221J	CHIP R 220 J 1/16W		9
R502,503			RK73GB1J473J	CHIP R 47K J 1/16W		9
R505			RK73GB1J103J	CHIP R 10K J 1/16W		
R514			RK73GB1J101J	CHIP R 100 J 1/16W		
R515			RK73GB1J221J	CHIP R 220 J 1/16W		
R516			RK73GB1J103J	CHIP R 10K J 1/16W		
R517			RK73GB1J221J	CHIP R 220 J 1/16W		
R518			RK73GB1J472J	CHIP R 4.7K J 1/16W		
R519			RK73GB1J221J	CHIP R 220 J 1/16W		
R520,521			RK73GB1J103J	CHIP R 10K J 1/16W		
R522,523			RK73GB1J472J	CHIP R 4.7K J 1/16W		
R524			RK73GB1J333J	CHIP R 33K J 1/16W		
R527			RK73GB1J103J	CHIP R 10K J 1/16W		
R528,529			RK73GB1J221J	CHIP R 220 J 1/16W		
R532-536			RK73GB1J221J	CHIP R 220 J 1/16W		5678
R601-603			RK73GB1J221J	CHIP R 220 J 1/16W		9
R605			RK73GB1J103J	CHIP R 10K J 1/16W		9
R614			RK73GB1J101J	CHIP R 100 J 1/16W		9
R615			RK73GB1J221J	CHIP R 220 J 1/16W		9
R616			RK73GB1J103J	CHIP R 10K J 1/16W		9
R617			RK73GB1J221J	CHIP R 220 J 1/16W		9
R618			RK73GB1J472J	CHIP R 4.7K J 1/16W		9
R619			RK73GB1J221J	CHIP R 220 J 1/16W		9
R620,621			RK73GB1J103J	CHIP R 10K J 1/16W		9
R622,623			RK73GB1J472J	CHIP R 4.7K J 1/16W		9
R624			RK73GB1J333J	CHIP R 33K J 1/16W		9
R627			RK73GB1J103J	CHIP R 10K J 1/16W		9
R628,629			RK73GB1J221J	CHIP R 220 J 1/16W		9
R652			RK73GB1J223J	CHIP R 22K J 1/16W		
R653			RK73GB1J102J	CHIP R 1.0K J 1/16W		
R654			RK73GB1J103J	CHIP R 10K J 1/16W		
R655			RK73GB1J223J	CHIP R 22K J 1/16W		9
R656			RK73GB1J102J	CHIP R 1.0K J 1/16W		9
R657			RK73GB1J103J	CHIP R 10K J 1/16W		9
R658			RK73GB1J102J	CHIP R 1.0K J 1/16W		
R660			RD14NB2E561J	RD 560 J 1/4W		
R661			RK73GB1J102J	CHIP R 1.0K J 1/16W		9
R662,663		*	R92-4558-05	METAL GLAZE 47 J 1/4W		
R701,702			RK73GB1J473J	CHIP R 47K J 1/16W		
R703,704			RK73GB1J103J	CHIP R 10K J 1/16W		
R705,706			RK73GB1J472J	CHIP R 4.7K J 1/16W		
R707,708			RK73GB1J474J	CHIP R 470K J 1/16W		
R709,710			RK73GB1J473J	CHIP R 47K J 1/16W		

L : Scandinavia K : USA P : Canada R : Mexico C : China I : Malaysia
 Y : PX(Far East,Hawaii) T : England E : Europe G : Germany V : China(Shanghai)
 Y : AAFES(Europe) X : Australia Q : Russia H : Korea M : Other Areas Δ indicates safety critical components .

* New Parts
 Parts without **Parts No.** are not supplied.
 Les articles non mentionnés dans le **Parts No.** ne sont pas fournis.
 Teile ohne **Parts No.** werden nicht geliefert.

Ref. No	Add-ress	New Parts	Parts No.	Description	Desti-nation	Re-marks
R711,712			RK73GB1J221J	CHIP R 220 J 1/16W		9
R713,714			RK73GB1J102J	CHIP R 1.0K J 1/16W		9
R715,716			RK73GB1J103J	CHIP R 10K J 1/16W		
R801,802			RK73GB1J473J	CHIP R 47K J 1/16W		
R803,804			RK73GB1J103J	CHIP R 10K J 1/16W		
R805,806			RK73GB1J472J	CHIP R 4.7K J 1/16W		
R807,808			RK73GB1J474J	CHIP R 470K J 1/16W		
R809,810			RK73GB1J473J	CHIP R 47K J 1/16W		
R811,812			RK73GB1J221J	CHIP R 220 J 1/16W		9
R813,814			RK73GB1J102J	CHIP R 1.0K J 1/16W		9
R815,816			RK73GB1J473J	CHIP R 47K J 1/16W		9
R817,818			RK73GB1J103J	CHIP R 10K J 1/16W		
R901,902			RK73GB1J473J	CHIP R 47K J 1/16W		
R903,904			RK73GB1J103J	CHIP R 10K J 1/16W		
R905			RK73GB1J472J	CHIP R 4.7K J 1/16W		
R906			RK73GB1J911J	CHIP R 910 J 1/16W		
R907			RK73GB1J474J	CHIP R 470K J 1/16W		
R908			RK73GB1J103J	CHIP R 10K J 1/16W		
R909,910			RK73GB1J473J	CHIP R 47K J 1/16W		9
R911,912			RK73GB1J221J	CHIP R 220 J 1/16W		
R913,914			RK73GB1J102J	CHIP R 1.0K J 1/16W		9
R915,916			RK73GB1J103J	CHIP R 10K J 1/16W		
D1			DAN202U	DIODE		
D1			MA142WK	DIODE		
D1			1SS301	DIODE		
D2			DAP202U	DIODE		
D2			MA142WA	DIODE		
D2			1SS300	DIODE		
D3			DAN202U	DIODE		
D3			MA142WK	DIODE		
D3			1SS301	DIODE		
D6			MA111	DIODE		
Δ D41			D2SBA20F03	DIODE		
D42,43	*		HZU5.6(B2)	ZENER DIODE		
D42,43			UDZ5.6B	ZENER DIODE		
D44	*		HZU3.9(B2)	ZENER DIODE		
D44			UDZ3.9B	ZENER DIODE		
D45	*		HZU3.9(B2)	ZENER DIODE		9
D45			UDZ3.9B	ZENER DIODE		
D46	*		HZU5.1(B2)	ZENER DIODE		
D46			UDZ5.1B	ZENER DIODE		
D47			MA111	DIODE		
D67	*		HZU5.1(B2)	ZENER DIODE		
D67			UDZ5.1B	ZENER DIODE		
D151,152	*		HZU7.5(B2)	ZENER DIODE		
D151,152			UDZ7.5B	ZENER DIODE		
IC1			NJM4565M	ANALOGUE IC		
IC1			NJM4565MD	IC(OP AMP X2)		
IC2	*		AK4527B-VQ	MOS-IC		
IC4	*		TC7WU04FU	MOS-IC		
IC5	*		AK4112AVF	MOS-IC		
IC6			TC7WH123FU	MOS-IC		
IC11			NJM4565M	ANALOGUE IC		
IC11			NJM4565MD	IC(OP AMP X2)		

L : Scandinavia K : USA P : Canada R : Mexico C : China I : Malaysia
 Y : PX(Far East,Hawaii) T : England E : Europe G : Germany V : China(Shanghai)
 Y : AAFES(Europe) X : Australia Q : Russia H : Korea M : Other Areas Δ indicates safety critical components .

* New Parts
 Parts without **Parts No.** are not supplied.
 Les articles non mentionnés dans le **Parts No.** ne sont pas fournis.
 Teile ohne **Parts No.** werden nicht geliefert.

Ref. No	Add-ress	New Parts	Parts No.	Description	Desti-nation	Re-marks
IC12			NJU7311AM	MOS-IC		
IC13			NJM4565M	ANALOGUE IC		
IC13			NJM4565MD	IC(OP AMP X2)		
IC14			NJU7311AM	MOS-IC		5679
IC15			M62446FP	ANALOGUE IC		
IC21			NJM4565M	ANALOGUE IC		
IC21			NJM4565MD	IC(OP AMP X2)		
IC31			NJM4565M	ANALOGUE IC		
IC31			NJM4565MD	IC(OP AMP X2)		
IC41			TC74HC07AF	MOS-IC		
IC42			TC74HCT7007AF	MOS-IC		
Δ IC45			BA05T	ANALOGUE IC		
Δ IC46			BA033LBSG	ANALOGUE IC		
Δ IC47			XC62EP2502MR	ANALOGUE IC		9
Δ IC48			XC62EP2502MR	ANALOGUE IC		
IC51			CS493263-CLR	MOS-IC		
IC61	*		CS493302-CLR	MOS-IC		9
IC70			NJM4565M	ANALOGUE IC		
IC70			NJM4565MD	IC(OP AMP X2)		
IC80			NJM4565M	ANALOGUE IC		
IC80			NJM4565MD	IC(OP AMP X2)		
IC90			NJM4565MD	ANALOGUE IC		
IC90			NJM4565MD	IC(OP AMP X2)		
Q1			DTC124EUA	DIGITAL TRANSISTOR		
Q1			UN5212	DIGITAL TRANSISTOR		
Δ Q15			2SD1664(Q,R)	TRANSISTOR		
Δ Q16			2SB1132(Q,R)	TRANSISTOR		
Q41			2SC4081(R,S)	TRANSISTOR		
Q41			2SD1819A(Q,R)	TRANSISTOR		
Q42			2SA1576A(R,S)	TRANSISTOR		
Q42			2SB1218A(Q,R)	TRANSISTOR		
Q47			2SB1375	TRANSISTOR		
Q48			2SB1375	TRANSISTOR		9
Q49,50			DTC124EUA	DIGITAL TRANSISTOR		
Q49,50			UN5212	DIGITAL TRANSISTOR		
Q65			DTA124EUA	DIGITAL TRANSISTOR		
Q65			UN5112	DIGITAL TRANSISTOR		
Q66			DTA124EUA	DIGITAL TRANSISTOR		9
Q66			UN5112	DIGITAL TRANSISTOR		9
Q71,72			2SC4213(B)	TRANSISTOR		
Q73,74			2SC4213(B)	TRANSISTOR		9
Q81,82			2SC4213(B)	TRANSISTOR		
Q83,84			2SC4213(B)	TRANSISTOR		9
Q91,92			2SC4213(B)	TRANSISTOR		
Q93,94			2SC4213(B)	TRANSISTOR		9
A1	*		W02-2802-05	OPTIC RECEIVING MODULE		79
A2	*		W02-2802-05	OPTIC RECEIVING MODULE		
A3	*		W02-2803-05	OSCILLATING MODULE		9
DISPLAY UNIT (X14-725X/726X-XX)						
D1 -4			B30-2545-05	LED(RED3(160))		
D5,6			B30-2545-05	LED(RED3(160))		79
C1			CE04RW0J470M	ELECTRO 47UF	6.3WV	
C10 -12			CK45FF1H103Z	CERAMIC 0.010UF	Z	
C13,14			CK73GB1H103K	CHIP C 0.010UF	K	

L : Scandinavia K : USA P : Canada R : Mexico C : China I : Malaysia
 Y : PX(Far East,Hawaii) T : England E : Europe G : Germany V : China(Shanghai)
 Y : AAFES(Europe) X : Australia Q : Russia H : Korea M : Other Areas Δ indicates safety critical components .

KRF-V5050D/V5550D/V6050D/V7050D/X9050D
PARTS LIST

* New Parts
Parts without **Parts No.** are not supplied.
Les articles non mentionnés dans le **Parts No.** ne sont pas fournis.
Teile ohne **Parts No.** werden nicht geliefert.

21

Ref. No	Add-ress	New Parts	Parts No.	Description	Desti-nation	Re-marks	
C15 ,16			CK45FF1H103Z	CERAMIC	0.010UF	Z	79
C17 -21			CC45FSL1H101J	CERAMIC	100PF	J	679
C22 ,23			CQ93FMG1H471J	MYLAR	470PF	J	
C24			CE04HW1H100M	NP-ELEC	10UF	50WV	
C26			CC45FSL1H101J	CERAMIC	100PF	J	
C27			CE04RW1A101M	ELECTRO	100UF	10WV	
C28			CE04KW1V470M	ELECTRO	47UF	35WV	
C29			CE04RW1H330M	ELECTRO	33UF	50WV	
C30			CQ93FMG1H471J	MYLAR	470PF	J	679
C31 ,32			CE04RW1H010M	ELECTRO	1.0UF	50WV	
C100-105			CC45FSL1H221J	CERAMIC	220PF	J	9
C106			CE04RW1V2R2M	ELECTRO	2.2UF	35WV	5679
C106			CE04RW1V2R2M	ELECTRO	2.2UF	35WV	5
C107			CC73GCH1H271J	CHIP C	270PF	J	5679
C107			CC73GCH1H271J	CHIP C	270PF	J	E2E3T2
C108			CK73GB1H103K	CHIP C	0.010UF	K	ET 679
C110			CE04KW1A470M	ELECTRO	47UF	10WV	ET 679
C111			CK73GB1H103K	CHIP C	0.010UF	K	ET 679
C112,113			CC45FCH1H270J	CERAMIC	27PF	J	ET 679
C114			CC45FSL1H101J	CERAMIC	100PF	J	ET 679
C115			CK73GB1H103K	CHIP C	0.010UF	K	
C125			CK45FB1H561K	CERAMIC	560PF	K	ET 5679
C125			CK45FB1H561K	CERAMIC	560PF	K	E2E3T2 5
C201			CC45FSL1H221J	CERAMIC	220PF	J	
C202			CQ93FMG1H103J	MYLAR	0.010UF	J	
C203			CE04PW1E470M	ELECTRO	47UF	25WV	9
C204			CC45FSL1H101J	CERAMIC	100PF	J	YMI
C205,206			CQ93FMG1H102J	MYLAR	1000PF	J	679
C207,208			CK73GB1H102K	CHIP C	1000PF	K	
C209,210			CC45FSL1H470J	CERAMIC	47PF	J	
C211			CE04PW1E470M	ELECTRO	47UF	25WV	
C212			CC45FSL1H470J	CERAMIC	47PF	J	
C213			CE04PW1E470M	ELECTRO	47UF	25WV	
C214			CC45FSL1H470J	CERAMIC	47PF	J	
C215			CE04PW1E470M	ELECTRO	47UF	25WV	79
C216			CC45FSL1H470J	CERAMIC	47PF	J	79
C217			CE04PW1E470M	ELECTRO	47UF	25WV	
C218			CC45FSL1H470J	CERAMIC	47PF	J	
C219			CC45FSL1H470J	CERAMIC	47PF	J	
C229,230			CE04PW1H100M	ELECTRO	10UF	50WV	9
C243,244			CC73GCH1H101J	CHIP C	100PF	J	
C245			CK73GB1H103K	CHIP C	0.010UF	K	
C246			CC45FSL1H221J	CERAMIC	220PF	J	
C247,248			CQ93FMG1H103J	MYLAR	0.010UF	J	
C249,250			CK73GB1H103K	CHIP C	0.010UF	K	
C254			CE04RW1H2R2M	ELECTRO	2.2UF	50WV	YMI
C255			CK73GB1H103K	CHIP C	0.010UF	K	YMI
C256			CQ93FMG1H103J	MYLAR	0.010UF	J	YMI
C257			CC73GCH1H101J	CHIP C	100PF	J	YMI
C258			CK73GB1H103K	CHIP C	0.010UF	K	
C259			CE04PW1A101M	ELECTRO	100UF	10WV	
C261			C90-1826-05	BACKUP-C	0.047F	5.5WV	6789
C262			CE04PW1H010M	ELECTRO	1UF	50WV	6789
C263-265			CK73GB1H103K	CHIP C	0.010UF	K	
C284			CQ93FMG1H103J	MYLAR	0.010UF	J	

L : Scandinavia K : USA P : Canada R : Mexico C : China I : Malaysia
Y : PX(Far East,Hawaii) T : England E : Europe G : Germany V : China(Shanghai)
Y : AAFES(Europe) X : Australia Q : Russia H : Korea M : Other Areas Δ indicates safety critical components .

* New Parts
Parts without **Parts No.** are not supplied.
Les articles non mentionnés dans le **Parts No.** ne sont pas fournis.
Teile ohne **Parts No.** werden nicht geliefert.

22

Ref. No	Add-ress	New Parts	Parts No.	Description	Desti-nation	Re-marks	
C401-408			CC73GCH1H470J	CHIP C	47PF	J	67
C409-412			CC73GCH1H470J	CHIP C	47PF	J	7
C413,414			CK73GB1H103K	CHIP C	0.010UF	K	67
C415			CK73GB1H103K	CHIP C	0.010UF	K	7
C416			CK45FF1H103Z	CERAMIC	0.010UF	Z	7
C417			CK73GB1H103K	CHIP C	0.010UF	K	67
C418,419			CE04KW1E470M	ELECTRO	47UF	25WV	67
C420,421			CE04KW1E470M	ELECTRO	47UF	25WV	7
C422			CE04KW1E470M	ELECTRO	47UF	25WV	67
C424,425			CE04KW1V100M	ELECTRO	10UF	35WV	67
C501			CC45FSL1H101J	CERAMIC	100PF	J	
C503-505			CC45FSL1H101J	CERAMIC	100PF	J	679
C510-515			CC45FSL1H101J	CERAMIC	100PF	J	
C518			CC73GCH1H101J	CHIP C	100PF	J	
C539-542			CE04PW1H100M	ELECTRO	10UF	50WV	
CN1			E40-8504-05	FLAT CABLE CONNECTOR			
CN2			E40-3247-05	PIN ASSY			
CN3			E40-8477-05	FLAT CABLE CONNECTOR			679
CN100			E40-9825-05	SOCKET FOR PIN ASSY			9
CN101			E40-8429-05	SOCKET FOR PIN ASSY			
CN201			E40-8483-05	FLAT CABLE CONNECTOR			679
CN202			E40-8488-05	FLAT CABLE CONNECTOR			
CN203			E40-8483-05	FLAT CABLE CONNECTOR			
CN204			E40-8504-05	FLAT CABLE CONNECTOR			
CN205			E40-9833-05	SOCKET FOR PIN ASSY			
CN206			E40-4721-05	FLAT CABLE CONNECTOR			679
CN401			E40-8483-05	FLAT CABLE CONNECTOR			67
J1			E11-0272-05	PHONE JACK			
J2		*	E63-1172-05	PIN JACK			679
J3		*	E56-0033-05	CYLINDRICAL RECEPTACLE			679
J100			E63-1139-05	PIN JACK			9
J200			E11-0293-05	MINIATURE PHONE JACK(2P)			
J201			E63-0127-05	PIN JACK			79
J202			E63-0130-05	PIN JACK			9
J203			E63-0069-05	PIN JACK			568
J204			E63-0130-05	PIN JACK			568
J401,402			E56-0011-05	CYLINDRICAL RECEPTACLE			7
J403,404			E56-0023-05	CYLINDRICAL RECEPTACLE			6
-			J19-5928-13	HOLDER			
E1			J11-0808-05	WIRE CLAMPER			
E4			J11-0808-05	WIRE CLAMPER			679
L1			L92-0017-05	FERRITE CORE			679
X100			L77-2002-05	CRYSTAL RESONATOR(4.332MHZ)	ET		5679
X100			L77-2002-05	CRYSTAL RESONATOR(4.332MHZ)	E2E3T2		5
X200			L78-0725-05	RESONATOR (8.38MHZ)			
CP200			R90-0802-05	MULTI-COMP	100KX10	J 1/4W	
CP201,202			R90-0500-05	MULTI-COMP	100KX6	J 1/4W	
CP203			R90-0855-05	MULTI-COMP	100KX5	J	
CP205			R90-0802-05	MULTI-COMP	100KX10	J 1/4W	
CP206			R90-0482-05	MULTI-COMP	100KX4	J 1/6W	
R2			RK73GB1J563J	CHIP R	56K	J 1/16W	
R6 ,7			RD14BB2C471J	RD	470	J 1/6W	79
R28			RD14BB2C103J	RD	10K	J 1/6W	79
R30			RD14BB2C103J	RD	10K	J 1/6W	79

L : Scandinavia K : USA P : Canada R : Mexico C : China I : Malaysia
Y : PX(Far East,Hawaii) T : England E : Europe G : Germany V : China(Shanghai)
Y : AAFES(Europe) X : Australia Q : Russia H : Korea M : Other Areas Δ indicates safety critical components .

PARTS LIST

KRF-V5050D/V5550D/V6050D/V7050D/X9050D

* New Parts
 Parts without **Parts No.** are not supplied.
 Les articles non mentionnés dans le **Parts No.** ne sont pas fournis.
 Teile ohne **Parts No.** werden nicht geliefert.

Ref. No	Add-ress	New Parts	Parts No.	Description	Desti-nation	Re-marks
R32 ,33			RD14BB2C101J	RD 100 J 1/6W		568
R40			RD14BB2C750J	RD 75 J 1/6W		679
R50 ,51			RD14BB2C101J	RD 100 J 1/6W		679
R52 ,53			RD14BB2C104J	RD 100K J 1/6W		679
R54			RD14BB2C101J	RD 100 J 1/6W		679
R55			RD14BB2C820J	RD 82 J 1/6W		679
R56			RD14BB2C750J	RD 75 J 1/6W		679
R65			RD14BB2C1R0J	RD 1 J 1/6W		
R66			RD14NB2E2R2J	RD 2.2 J 1/4W		
R67 ,68			RD14BB2C101J	RD 100 J 1/6W		679
R100-105			RD14BB2C470J	RD 47 J 1/6W		9
R106-111			RD14BB2C104J	RD 100K J 1/6W		9
R112-117			RD14BB2C221J	RD 220 J 1/6W		9
R118-123			RD14BB2C102J	RD 1.0K J 1/6W		9
R124			RD14BB2C473J	RD 47K J 1/6W	ET	5679
R124			RD14BB2C473J	RD 47K J 1/6W	E2E3T2	5
R125			RD14BB2C1R0J	RD 1 J 1/6W	ET	5679
R125			RD14BB2C1R0J	RD 1 J 1/6W	E2E3T2	5
R209			RD14BB2C101J	RD 100 J 1/6W		9
R210			RD14BB2C512J	RD 5.1K J 1/6W		9
R217			RD14BB2C820J	RD 82 J 1/6W		79
R220			RD14BB2C680J	RD 68 J 1/6W		9
R221			RD14BB2C104J	RD 100K J 1/6W		9
R223,224			RD14BB2C221J	RD 220 J 1/6W		679
R229,230			RD14BB2C1R0J	RD 1 J 1/6W		
R231			RK73GB1J101J	CHIP R 100 J 1/16W		
R232			RK73GB1J103J	CHIP R 10K J 1/16W		
R233			RK73GB1J101J	CHIP R 100 J 1/16W		
R239			RK73GB1J221J	CHIP R 220 J 1/16W		
R240-242			RK73GB1J101J	CHIP R 100 J 1/16W		
R243-247			RK73GB1J221J	CHIP R 220 J 1/16W		
R251-255			RK73GB1J101J	CHIP R 100 J 1/16W		
R256			RK73GB1J104J	CHIP R 100K J 1/16W		
R260			RD14NB2E222J	RD 2.2K J 1/4W	YMI	
R262,263			RK73GB1J102J	CHIP R 1.0K J 1/16W		
R264			RK73GB1J103J	CHIP R 10K J 1/16W		
R265			RK73GB1J102J	CHIP R 1.0K J 1/16W		
R266			RK73GB1J104J	CHIP R 100K J 1/16W		
R267,268			RK73GB1J103J	CHIP R 10K J 1/16W		
R269			RK73GB1J102J	CHIP R 1.0K J 1/16W		
R288			RK73GB1J101J	CHIP R 100 J 1/16W	X	5679
R295			RD14BB2C103J	RD 10K J 1/6W		67
R296			RD14BB2C2R2J	RD 2.2 J 1/6W		
R297-299			RK73GB1J221J	CHIP R 220 J 1/16W		
R301			RD14BB2C432J	RD 4.3K J 1/6W		9
R302			RD14BB2C822J	RD 8.2K J 1/6W		9
R303			RD14BB2C122J	RD 1.2K J 1/6W		9
R304,305			RK73GB1J101J	CHIP R 100 J 1/16W		
R310			RK73GB1J104J	CHIP R 100K J 1/16W	XTE	9
R310			RK73GB1J104J	CHIP R 100K J 1/16W	Y	
R311,312			RK73GB1J104J	CHIP R 100K J 1/16W		
R315,316			RK73GB1J104J	CHIP R 100K J 1/16W		67
R401,402			RK73GB1J104J	CHIP R 100K J 1/16W		67
R403,404			RK73GB1J820J	CHIP R 82 J 1/16W		67
R405,406			RK73GB1J104J	CHIP R 100K J 1/16W		67

L : Scandinavia K : USA P : Canada R : Mexico C : China I : Malaysia
 Y : PX(Far East,Hawaii) T : England E : Europe G : Germany V : China(Shanghai)
 Y : AAFES(Europe) X : Australia Q : Russia H : Korea M : Other Areas Δ indicates safety critical components .

* New Parts
 Parts without **Parts No.** are not supplied.
 Les articles non mentionnés dans le **Parts No.** ne sont pas fournis.
 Teile ohne **Parts No.** werden nicht geliefert.

Ref. No	Add-ress	New Parts	Parts No.	Description	Desti-nation	Re-marks
R407,408			RK73GB1J820J	CHIP R 82 J 1/16W		67
R409-412			RK73GB1J820J	CHIP R 82 J 1/16W		7
R413			RK73GB1J680J	CHIP R 68 J 1/16W		7
R414			RD14BB2C680J	RD 68 J 1/6W		7
R415,416			RK73GB1J680J	CHIP R 68 J 1/16W		7
R417			RD14BB2C472J	RD 4.7K J 1/6W		7
R419,420			RD14BB2C4R7J	RD 4.7 J 1/6W		7
R421,422			RK73GB1J1R0J	CHIP R 1 J 1/16W		6
R423			RK73GB1J1R0J	CHIP R 1 J 1/16W		7
R424,425			RK73GB1J1R0J	CHIP R 1 J 1/16W		6
S1 -13			S70-0031-05	TACT SWITCH		
S1 -13			S70-0086-05	TACT SWITCH		
S17 ,18			S70-0031-05	TACT SWITCH		568
S17 ,18			S70-0086-05	TACT SWITCH		568
S100			S68-0107-05	PUSH SWITCH		
S200			S62-0034-05	SLIDE SWITCH	YMI	
S14			T99-0630-05	ROTARY ENCODER		
S15			T99-0602-05	ROTARY ENCODER		
S16			T99-0630-05	ROTARY ENCODER		79
D7			HZS6.2N(B2)	ZENER DIODE		
D7			MTZJ6.2(B)	ZENER DIODE		
D7			RD6.2ES(B)	ZENER DIODE		
D9 -11			HSS104A	DIODE		
D9 -11			1SS133	DIODE		
D12 -15			HSS104A	DIODE		679
D12 -15			1SS133	DIODE		679
D200-207			HSS104A	DIODE		
D200-207			1SS133	DIODE		
D209,210			HZS5.6N(B2)	ZENER DIODE		
D209,210			MTZJ5.6(B)	ZENER DIODE		
D209,210			RD5.6ES(B)	ZENER DIODE		
D211			HSS104A	DIODE	YMI	
D211			1SS133	DIODE	YMI	
D212,213			RB721Q	DIODE		
D214-216			HSS104A	DIODE		
D214-216			1SS133	DIODE		
D220,221			HSS104A	DIODE		9
D220,221			1SS133	DIODE		9
D401			HSS104A	DIODE		67
D401			1SS133	DIODE		67
ED2			HNA-11MS24	FLUORESCENT INDICATOR TUBE		
ED2			11-MT-125GK	FLUORESCENT INDICATOR TUBE		
IC1			UPD16311	MOS-IC		
IC100			BU1923	ANALOGUE IC	ET	5679
IC100			BU1923	ANALOGUE IC	E2E3T2	5
IC200		*	MN101C49GLE	MI-COM IC		568
IC200		*	MN101C49HLD	MI-COM IC		9
IC200		*	MN101C49HLF	MI-COM IC		7
IC201			NJM2279D	ANALOGUE IC		
IC202			NJU4052BD	IC(4CH MPX/DE-MPX)		679
IC202			TC74HC4052AP	IC(ANALOG MULTIPLEXER)		679
IC204			S-80840ANY	ANALOGUE IC		
IC205			S-80840ANY	ANALOGUE IC	YMI	
IC207			XC62FP5102P	ANALOGUE IC		

L : Scandinavia K : USA P : Canada R : Mexico C : China I : Malaysia
 Y : PX(Far East,Hawaii) T : England E : Europe G : Germany V : China(Shanghai)
 Y : AAFES(Europe) X : Australia Q : Russia H : Korea M : Other Areas Δ indicates safety critical components .

KRF-V5050D/V5550D/V6050D/V7050D/X9050D
PARTS LIST

* New Parts
Parts without **Parts No.** are not supplied.
Les articles non mentionnés dans le **Parts No.** ne sont pas fournis.
Teile ohne **Parts No.** werden nicht geliefert.

25

Ref. No	Add-ress	New Parts	Parts No.	Description	Desti-nation	Re-marks
IC401,402 IC403 Q1 Q1 Q100-105			NJM2279M TC74HC4052AF KTC3199(Y,GR) 2SC1740S(Q,R) 2SC2878(B)	ANALOGUE IC MOS-IC TRANSISTOR TRANSISTOR TRANSISTOR		67 7 9
Q200,201 Q200,201 Q202 Q202 Q203			KTC3199(Y,GR) 2SC1740S(Q,R) KTA1273 2SA1534A(R,S) 2SC3940A(R,S)	TRANSISTOR TRANSISTOR TRANSISTOR TRANSISTOR TRANSISTOR		9 9 9
Q203 Q204 Q204 Q205 Q205			2SD1768S KTC3199(Y,GR) 2SC1740S(Q,R) KTA1267(Y,GR) 2SA933AS(Q,R)	TRANSISTOR TRANSISTOR TRANSISTOR TRANSISTOR TRANSISTOR		9 9
Q401 Q401			DTC124ESA UN4212	DIGITAL TRANSISTOR DIGITAL TRANSISTOR		6 6
A2			W02-2625-05	OPTIC RECEIVING MODULE		
VIDEO UNIT (X35-2252-71)						
C1 -12 C13 -17 C18 -21 C22 C31			CC45FSL1H470J CK45FF1H103Z CE04PW1C470M CE04PW1E470M CK45FF1H103Z	CERAMIC CERAMIC ELECTRO ELECTRO CERAMIC	47PF 0.010UF 47UF 47UF 0.010UF	J Z 16WV 25WV Z
C32 ,33 C53 ,54 C101 C102 C103			CE04LW1V100M CE04LW1V100M CC45FSL1H470J CE04PW1E470M CC45FSL1H470J	ELECTRO ELECTRO CERAMIC ELECTRO CERAMIC	10UF 10UF 47PF 47UF 47PF	35WV 35WV J 25WV J
C104 C105 C106 C107 C108			CE04PW1E470M CC45FSL1H470J CE04PW1E470M CC45FSL1H470J CE04PW1E470M	ELECTRO CERAMIC ELECTRO CERAMIC ELECTRO	47UF 47PF 47UF 47PF 47UF	25WV J 25WV J 25WV
C109 C110 C111 C112 C121-123			CC45FSL1H470J CE04PW1E470M CC45FSL1H470J CE04PW1E470M CC45FSL1H470J	CERAMIC ELECTRO CERAMIC ELECTRO CERAMIC	47PF 47UF 47PF 47UF 47PF	J 25WV J 25WV J
C131-133 C141,142 C143			CK45FF1H103Z CE04LW1V100M CK45FF1H103Z	CERAMIC ELECTRO CERAMIC	0.010UF 10UF 0.010UF	Z 35WV Z
CN1 J1 ,2 J11 J11 J11			E40-8483-05 E56-0011-05 E63-1193-05 E63-1195-05 E63-1197-05	FLAT CABLE CONNECTOR CYLINDRICAL RECEPTACLE PIN JACK PIN JACK PIN JACK		
J12 J12 J12		*	E63-1194-05 E63-1196-05 E63-1198-05	PIN JACK PIN JACK PIN JACK		
E1			J11-0809-05	WIRE CLAMPER		
R31 ,32			RD14NB2E4R7J	RD	4.7	J 1/4W

L : Scandinavia K : USA P : Canada R : Mexico C : China I : Malaysia
Y : PX(Far East,Hawaii) T : England E : Europe G : Germany V : China(Shanghai)
Y : AAFES(Europe) X : Australia Q : Russia H : Korea M : Other Areas Δ indicates safety critical components .

* New Parts
Parts without **Parts No.** are not supplied.
Les articles non mentionnés dans le **Parts No.** ne sont pas fournis.
Teile ohne **Parts No.** werden nicht geliefert.

26

Ref. No	Add-ress	New Parts	Parts No.	Description	Desti-nation	Re-marks
R51 ,52 R141,142			RS14KB3D220J RD14NB2E4R7J	FL-PROOF RS RD	22 4.7	J 2W J 1/4W
D51 ,52 D51 ,52 D51 ,52 D51 ,52			HZS5.6N(B2) MTZJ5.6 MTZJ5.6(B) RD5.6ES(B) RD5.6ES(B2)	ZENER DIODE ZENER DIODE ZENER DIODE ZENER DIODE ZENER DIODE		
D101-103 D101-103 D101-103 IC1 ,2 IC3			HSS104 HSS104A 1SS133 NJM2279D NJU4052BD	DIODE DIODE DIODE ANALOGUE IC IC(4CH MPX/DE-MPX)		
IC3 IC11-13 Q51 Q52 Q101			TC74HC4052AP NJM2279D 2SD2525 2SB1640 DTC124ESA	IC(ANALOG MULTIPLEXER) ANALOGUE IC TRANSISTOR TRANSISTOR DIGITAL TRANSISTOR		
Q101			UN4212	DIGITAL TRANSISTOR		

L : Scandinavia K : USA P : Canada R : Mexico C : China I : Malaysia
Y : PX(Far East,Hawaii) T : England E : Europe G : Germany V : China(Shanghai)
Y : AAFES(Europe) X : Australia Q : Russia H : Korea M : Other Areas Δ indicates safety critical components .

HOW TO READ THE PARTS LIST

ABBREVIATION OF MODEL AND MASS PRODUCTION'S DESTINATIONS

MODEL	ABB.	Australia	Canada	China	England	Europe	Germany	Korea	Malaysia
KRF-V5050D		-	-	-	T	E	-	-	-
KRF-V5050DE	5	-	-	-	-	E3	-	-	-
KRF-V5050D-S		X	-	-	T2	E2	-	-	I
KRF-V5550D-S	8	-	-	-	-	-	-	-	-
KRF-V6050D		-	-	-	-	E	-	-	-
KRF-V6050D-S	6	X	-	-	-	-	-	-	I
KRF-V7050D		-	-	-	T	E	-	-	-
KRF-V7050D-S	7	X	-	-	-	-	-	-	I
KRF-X9050D		-	-	-	T	E	-	-	-
KRF-X9050D-S	9	X	-	-	-	-	-	-	I
MODEL	ABB.	Mexico	PX/AAFES	Russia	Scandinavia	Shanghai	USA	Other area	
KRF-V5050D		-	Y	-	-	-	-	-	-
KRF-V5050DE	5	-	-	-	-	-	-	-	-
KRF-V5050D-S		-	-	-	-	-	-	-	-
KRF-V5550D-S	8	-	Y	-	-	-	-	M	-
KRF-V6050D		-	Y	-	-	-	-	-	-
KRF-V6050D-S	6	-	-	-	-	-	-	M	-
KRF-V7050D		-	Y	-	-	-	-	-	-
KRF-V7050D-S	7	-	-	-	-	-	-	M	-
KRF-X9050D		-	Y	-	-	-	-	-	-
KRF-X9050D-S	9	-	-	-	-	-	-	M	-

PARTS LIST

KRF-V5050D/V5550D/V6050D/V7050D/X9050D

SPECIFICATIONS

For Europe

AUDIO section (KRF-V6050D)

Rated power output during STEREO operation	
DIN/IEC (DIN 1kHz, 0.7% T.H.D., at 6 Ω)	110 W + 110 W
Effective power output during SURROUND operation	
FRONT (1kHz, 0.7% T.H.D. at 6 Ω, one channel driven)	
.....	100 W + 100 W
CENTER (1kHz, 0.7% T.H.D. at 6 Ω, one channel driven)	
.....	100 W
SURROUND (1kHz, 0.7% T.H.D. at 6 Ω, one channel driven)	
.....	100 W + 100 W
Total harmonic distortion	0.050% (1 kHz, 50W, 6 Ω)
Frequency response (IHF '66)	
CD	10 Hz ~ 60 kHz, +0 dB, -3.0 dB
Signal to noise ratio (IHF'66)	
PHONO (MM)	74 dB
CD	90 dB
Input sensitivity / impedance	
PHONO (MM)	2.5 mV / 27 kΩ
CD	200 mV / 47 kΩ
VIDEO2/MONITOR	200 mV / 47 kΩ
DVD/6ch INPUT	200 mV / 10 kΩ
Output level / impedance	
TAPE REC	200 mV / 1 kΩ
VIDEO2/MONITOR	200 mV / 1 kΩ
PRE OUT (SUBWOOFER)	1.5 V / 2.2 kΩ
Tone control	
BASS	±10 dB (at 70 Hz)
TREBLE	±10 dB (at 10 kHz)

AUDIO section (KRF-V5050D)

Rated power output during STEREO operation	
DIN/IEC (DIN 1 kHz, 0.7% T.H.D., 6 Ω)	110 W + 110 W
Effective power output during SURROUND operation	
FRONT (1kHz, 0.7% T.H.D. at 6 Ω, one channel driven)	
.....	100 W + 100 W
CENTER (1kHz, 0.7% T.H.D. at 6 Ω, one channel driven)	
.....	100 W
SURROUND (1kHz, 0.7% T.H.D. at 6 Ω, one channel driven)	
.....	100 W + 100 W
Total harmonic distortion	0.050% (1 kHz, 50W, 6 Ω)
Frequency response (IHF '66)	
CD	40 Hz ~ 60 kHz, +0 dB, -3.0 dB
Signal to noise ratio (IHF'66)	
PHONO (MM)	74 dB
CD	90 dB
Input sensitivity / impedance	
PHONO (MM)	2.5 mV / 27 kΩ
CD	200 mV / 47 kΩ
MONITOR IN (VIDEO2/MONITOR)	200 mV / 47 kΩ
DVD/6ch INPUT	200 mV / 47 kΩ
Output level / impedance	
TAPE REC	200 mV / 1 kΩ
MONITOR OUT (VIDEO2/MONITOR)	200 mV / 1 kΩ
PRE OUT (SUBWOOFER)	1.5 V / 2.2 kΩ
Tone control	
BASS	±10 dB (at 70 Hz)
TREBLE	±10 dB (at 10 kHz)

DIGITAL AUDIO section

Sampling frequency	32 kHz, 44.1 kHz, 48 kHz, 96kHz
Input level / impedance / wave length	
Optical	(-15 dBm ~ -21 dBm), 660 nm ±30nm
Coaxial	0.5 Vp-p / 75 Ω

VIDEO section

VIDEO inputs / outputs	
VIDEO (composite)	1 Vp-p / 75 Ω
S-VIDEO inputs / outputs (KRF-V6050D)	
S-VIDEO (luminance signal)	1 Vp-p / 75 Ω
(chrominance signal)	0.286 Vp-p / 75 Ω

FM tuner section

Tuning frequency range	87.5 MHz ~ 108 MHz
Usable sensitivity (DIN at 75 Ω)	
MONO	1.3 μV/13.2 dBf (40 kHz dev. S/N 26 dB)
STEREO	45 μV/42.1 dBf (46 kHz dev. S/N 46 dB)
Total harmonic distortion (1 kHz)	
MONO	0.2% (71.2 dBf input)
STEREO	0.8% (71.2 dBf input)
Signal to noise ratio (DIN weighted)	
MONO	65 dB (40 kHz dev. 71.2 dBf input)
STEREO	60 dB (46 kHz dev. 71.2 dBf input)
Stereo separation (DIN 1 kHz)	36 dB
Selectivity (DIN ± 300 kHz)	64 dB
Frequency response	(30 Hz ~ 15kHz), +0.5 dB, -3.0 dB

AM tuner section

Tuning frequency range	531 kHz ~ 1,602 kHz
Usable sensitivity	16 μV / (600 μV/m)
Signal to noise ratio (30% mod. 1 mV input)	50 dB

GENERAL

Power consumption	250 W
AC outlet	
SWITCHED	(total 90 W max.)
Dimensions	W : 440 mm
	H : 143 mm
	D : 400 mm
Weight	
KRF-V6050D	8.6 kg
KRF-V5050D	8.5 kg

Notes

1. KENWOOD follows a policy of continuous advancements in development. For this reason specifications may be changed without notice.
2. The full performance may not be exhibited in an extremely cold location (under a water-freezing temperature).

KRF-V5050D/V5550D/V6050D/V7050D/X9050D

SPECIFICATIONS

For other countries

AUDIO section (KRF-V6050D)

Effective power output during STEREO operation
1kHz, 10% T.H.D., at 8 Ω 140 W + 140 W
Rated power output during STEREO operation

100 watts per channel minimum RMS, both channels driven, at 8 Ω from 40 Hz to 20 kHz with no more than 0.7% total harmonic distortion. (FTC)

Effective power output during SURROUND operation
FRONT (1kHz, 10% T.H.D. at 8 Ω one channel driven) 140 W + 140 W
CENTER (1kHz, 10% T.H.D. at 8 Ω one channel driven) 140 W
SURROUND (1kHz, 10% T.H.D. at 8 Ω one channel driven) 140 W + 140 W
Total harmonic distortion 0.050% (1 kHz, 50W, 8 Ω)
Frequency response
CD 10 Hz ~ 60 kHz, +0 dB, -3.0 dB
Signal to noise ratio (IHF'66)
PHONO (MM) 74 dB
CD 90 dB
Input sensitivity / impedance
PHONO (MM) 2.5 mV / 27 kΩ
CD 200 mV / 47 kΩ
VIDEO2/MONITOR 200 mV / 47 kΩ
DVD/6ch INPUT 200 mV / 47 kΩ
Output level / impedance
TAPE REC 200 mV / 1 kΩ
VIDEO2/MONITOR 200 mV / 1 kΩ
PRE OUT (SUBWOOFER) 1.5 V / 2.2 kΩ
Tone control
BASS ±10 dB (at 70 Hz)
TREBLE ±10 dB (at 10 kHz)

AUDIO section (KRF-V5050D)

Effective power output during STEREO operation
(1 kHz, 10%, 8Ω) 140 W + 140 W
Rated power output during STEREO operation

100 watts channel minimum RMS, both channels driven, at 8 Ω from 40 Hz to 20 kHz with no more than 0.7% total harmonic distortion. (FTC)

Effective power output during SURROUND operation
FRONT (1kHz, 10% T.H.D. at 8 Ω one channel driven) 140 W + 140 W
CENTER (1kHz, 10% T.H.D. at 8 Ω one channel driven) 140 W
SURROUND (1kHz, 10% T.H.D. at 8 Ω one channel driven) 140 W + 140 W
Total harmonic distortion 0.050% (1 kHz, 50W, 8 Ω)
Frequency response
CD 10 Hz ~ 60 kHz, +0 dB, -3.0 dB
Signal to noise ratio (IHF'66)
PHONO (MM) 74 dB
CD, TUNER, AUX, TAPE 90 dB
Input sensitivity / impedance
PHONO (MM) 2.5 mV / 27 kΩ
CD 200 mV / 47 kΩ
MONITOR IN (VIDEO2/MONITOR) 200 mV / 47 kΩ
DVD/6ch INPUT 200 mV / 10 kΩ
Output level / impedance
TAPE REC 200 mV / 1 kΩ
MONITOR OUT (VIDEO2/MONITOR) 200 mV / 1 kΩ
PRE OUT (SUBWOOFER) 1.5 V / 2.2 kΩ
Tone control
BASS ±10 dB (at 70 Hz)
TREBLE ±10 dB (at 10 kHz)

AUDIO section (KRF-V5550D)

Effective power output during SURROUND operation
(1kHz, 10%, 8Ω) 110 W + 110 W
Rated power output during STEREO operation

80 watts per channel minimum RMS, both channels driven, at 8 Ω from 40 Hz to 20 kHz with no more than 0.7% total harmonic distortion. (FTC)

Effective power output during SURROUND operation
FRONT (1kHz, 10% T.H.D. at 8 Ω one channel driven) 130 W + 130 W
CENTER (1kHz, 10% T.H.D. at 8 Ω one channel driven) 130 W
SURROUND (1kHz, 10% T.H.D. at 8 Ω one channel driven) 130 W + 130 W
SUBWOOFER (80Hz, 10% T.H.D. at 8 Ω one channel driven) 130 W
Total harmonic distortion 0.050% (1 kHz, 40W, 8 Ω)
Frequency response
CD 10 Hz ~ 60 kHz, +0 dB, -3.0 dB
Signal to noise ratio (IHF'66)
CD, TUNER, AUX, TAPE 90 dB
Input sensitivity / impedance
CD 200 mV / 47 kΩ
MONITOR IN (VIDEO2/MONITOR) 200 mV / 47 kΩ
Output level / impedance
TAPE REC 200 mV / 1 kΩ
MONITOR OUT (VIDEO2/MONITOR) 200 mV / 1 kΩ
Tone control
BASS ±10 dB (at 70 Hz)
TREBLE ±10 dB (at 10 kHz)

DIGITAL AUDIO section

Sampling frequency 32 kHz, 44.1 kHz, 48 kHz, 96kHz
Input level / impedance / wave length
Optical (-15 dBm ~ -21 dBm), 660 nm ±30nm
Coaxial 0.5 Vp-p / 75 Ω

VIDEO section

VIDEO inputs / outputs
VIDEO (composite) 1 Vp-p / 75 Ω
S VIDEO inputs / outputs (KRF-V6050D)
S VIDEO (luminance signal) 1 Vp-p / 75 Ω
S VIDEO (chrominance signal) 0.286 Vp-p / 75 Ω

FM tuner section

Tuning frequency range 87.5 MHz ~ 108 MHz
Usable sensitivity (MONO) 1.6 μV (75 Ω) / 15.2 dBf (75 kHz DEV., SINAD 30 dB)
50dB quieting sensitivity
STEREO 28 μV (75 W) / 40.2 dBf
Total harmonic distortion (1 kHz)
MONO 0.5% (71.2 dBf input)
STEREO 0.7% (71.2 dBf input)
Signal to noise ratio (1 kHz, 75 kHz DEV.)
MONO 75 dB (71.2 dBf input)
STEREO 68 dB (71.2 dBf input)
Stereo separation (1 kHz) 40 dB
Selectivity (±400 kHz) 50 dB
Frequency response (30 Hz ~ 15kHz), +0.5 dB, -3.0 dB

AM tuner section

Tuning frequency range
9 kHz step 531 kHz ~ 1,602 kHz
10 kHz step 530 kHz ~ 1,610 kHz
Usable sensitivity 16 μV / (600 μV/m)
Signal to noise ratio (30% mod. 1 mV input) 50 dB

GENERAL

Power consumption
KRF-V6050D/V5050D 270 W
KRF-V5550D 200 W
AC outlet
SWITCHED (total 90 W max.)
Dimensions W : 440 mm
H : 143 mm
D : 400 mm
Weight (Net)
(KRF-V6050D/V5050D) 9.3 kg
(KRF-V5550D) 8.4 kg

Notes

1. KENWOOD follows a policy of continuous advancements in development. For this reason specifications may be changed without notice.
2. The full performance may not be exhibited in an extremely cold location (under a water-freezing temperature).

KRF-V5050D/V5550D/V6050D/V7050D/X9050D

SPECIFICATIONS

For Europe

AUDIO section (KRF-V7050D)

Rated power output during STEREO operation	
DIN/IEC (DIN 1kHz, 0.7% T.H.D. at 6 Ω)	110 W + 110 W
Effective power output during SURROUND operation	
FRONT (63 Hz ~ 12.5kHz, 0.7% T.H.D. at 6 Ω, one channel driven)	100 W + 100 W
CENTER (63 Hz ~ 12.5kHz, 0.7% T.H.D. at 6 Ω, one channel driven)	100 W + 100 W
SURROUND (63 Hz ~ 12.5kHz, 0.7% T.H.D. at 6 Ω, one channel driven)	100 W + 100 W
Total harmonic distortion	0.050% (1 kHz, 50W, 6 Ω)
Frequency response (IHF '66)	
CD	10 Hz ~ 60 kHz, +0 dB, -3.0 dB
Signal to noise ratio (IHF '66)	
PHONO (MM)	75 dB
CD	91 dB
Input sensitivity / impedance	
PHONO (MM)	2.5 mV / 27 kΩ
CD	200 mV / 47 kΩ
MONITOR IN	200 mV / 47 kΩ
DVD/6ch INPUT	200 mV / 47 kΩ
Output level / impedance	
TAPE REC	200 mV / 1 kΩ
MONITOR OUT	200 mV / 1 kΩ
PRE OUT (SUBWOOFER)	1.5 V / 2.2 kΩ
Tone control	
BASS	±10 dB (at 70 Hz)
TREBLE	±10 dB (at 10 kHz)

DIGITAL AUDIO section

Sampling frequency	32 kHz, 44.1 kHz, 48 kHz, 96kHz
Input level / impedance / wave length	
Optical	(-15 dBm ~ -21 dBm), 660 nm ±30nm
Coaxial	0.5 Vp-p / 75 Ω

VIDEO section

VIDEO inputs / outputs	
VIDEO (composite)	1 Vp-p / 75 Ω
S-VIDEO inputs / outputs	
S-VIDEO (luminance signal)	1 Vp-p / 75 Ω
(chrominance signal)	0.286 Vp-p / 75 Ω

FM tuner section

Tuning frequency range	87.5 MHz ~ 108.0 MHz
Usable sensitivity (DIN at 75 Ω)	
MONO	1.3 μV/13.2 dBf (40 kHz dev. S/N 26 dB)
STEREO	45 μV/42.1 dBf (45 kHz dev. S/N 46 dB)
Total harmonic distortion (1 kHz)	
MONO	0.2% (65.2 dBf input)
STEREO	0.8% (65.2 dBf input)
Signal to noise ratio (DIN weighted)	
MONO	65 dB (40 kHz dev. 65.2 dBf input)
STEREO	60 dB (40 kHz dev. 65.2 dBf input)
Stereo separation (DIN 1 kHz)	36 dB
Selectivity (DIN ± 300 kHz)	64 dB
Frequency response	(30 Hz ~ 15kHz), +0.5 dB, -3.0 dB

MW tuner section

Tuning frequency range	531 kHz ~ 1,602 kHz
Usable sensitivity	16 μV / (600 μV/m)
Signal to noise ratio (30% mod. 1 mV input)	50 dB

GENERAL

Power consumption	250 W
AC outlet	
SWITCHED	(total 90 W max.)
Dimensions	W : 440 mm
	H : 144 mm
	D : 399 mm
Weight	8.5 kg

For other countries

AUDIO section (KRF-V7050D)

Effective power output during STEREO operation	
1kHz, 10% T.H.D. at 8 Ω	140 W + 140 W
Rated power output during STEREO operation	
Effective power output during SURROUND operation	
FRONT (1kHz, 10% T.H.D. at 8 Ω one channel driven)	140 W + 140 W
CENTER (1kHz, 10% T.H.D. at 8 Ω one channel driven)	140 W
SURROUND (1kHz, 10% T.H.D. at 8 Ω one channel driven)	140 W + 140 W
Total harmonic distortion	0.05 % (1 kHz, 50W, 8 Ω)
Frequency response	
CD	10 Hz ~ 60 kHz, +0 dB, -3.0 dB
Signal to noise ratio (IHF '66)	
PHONO (MM)	73 dB
CD	91 dB
Input sensitivity / impedance	
PHONO (MM)	2.5 mV / 27 kΩ
CD	200 mV / 47 kΩ
VIDEO2/MONITOR	200 mV / 47 kΩ
DVD/6CH INPUT	200 mV / 10 kΩ
Output level / impedance	
TAPE REC	200 mV / 1 kΩ
VIDEO2/MONITOR	200 mV / 1 kΩ
PRE OUT (SUBWOOFER)	1.5 V / 2.2 kΩ
Tone control	
BASS	±10 dB (at 70 Hz)
TREBLE	±10 dB (at 10 kHz)

DIGITAL AUDIO section

Sampling frequency	32 kHz, 44.1 kHz, 48 kHz, 96kHz
Input level / impedance / wave length	
Optical	(-15 dBm ~ -21 dBm), 660 nm ±30nm
Coaxial	0.5 Vp-p / 75 Ω

Notes

1. KENWOOD follows a policy of continuous advancements in development. For this reason specifications may be changed without notice.
2. The full performance may not be exhibited in an extremely cold location (under a water-freezing temperature).

VIDEO section

VIDEO inputs / outputs	
VIDEO (composite)	1 Vp-p / 75 Ω
S VIDEO inputs / outputs	
S VIDEO (luminance signal)	1 Vp-p / 75 Ω
S VIDEO (chrominance signal)	0.286 Vp-p / 75 Ω

FM tuner section

Tuning frequency range	87.5 MHz ~ 108.0 MHz
Usable sensitivity (MONO)	1.6 μV (75 Ω) / 15.2 dBf (75 kHz DEV., SINAD 30 dB)
50dB quieting sensitivity	
STEREO	28 μV (75 Ω) / 40.2 dBf
Total harmonic distortion (1 kHz)	
MONO	0.5% (65 dBf input)
STEREO	0.7% (65 dBf input)
Signal to noise ratio (1 kHz, 75 kHz DEV.)	
MONO	75 dB (65 dBf input)
STEREO	68 dB (65 dBf input)
Stereo separation (1 kHz)	40 dB
Selectivity (±400 kHz)	50 dB
Frequency response	(30 Hz ~ 15kHz), +0.5 dB, -3.0 dB

AM tuner section

Tuning frequency range	
9 kHz step	531 kHz ~ 1,602 kHz
10 kHz step	530 kHz ~ 1,610 kHz
Usable sensitivity (30% mod., S/N 20dB)	16 μV / (600 μV/m)
Signal to noise ratio (30% mod. 1 mV input)	50 dB

GENERAL

Power consumption	270 W
AC outlet	
SWITCHED	(total 90 W, 1.25A max.)
Dimensions	W : 440 mm (17-5/16")
	H : 144 mm (5-11/16")
	D : 399 mm (15-11/16")
Weight (Net)	9.3 kg (20.50 lb)

Note:

Component and circuit are subject to modification to insure best operation under differing local conditions. This manual is based on Europe (E) standard, and provides information on regional circuit modification through use of alternate schematic diagrams, and information on regional component variations through use of parts list.

KENWOOD CORPORATION

14-6, Dogenzaka 1-chome, Shibuya-ku, Tokyo, 150-8501 Japan

KENWOOD SERVICE CORPORATION

P.O. BOX 22745, 2201 East Dominguez St., Long Beach, CA 90801-5745, U.S.A.